

LED Drivers and Batteries for Emergency Lighting

EM converterLED ST

Manual

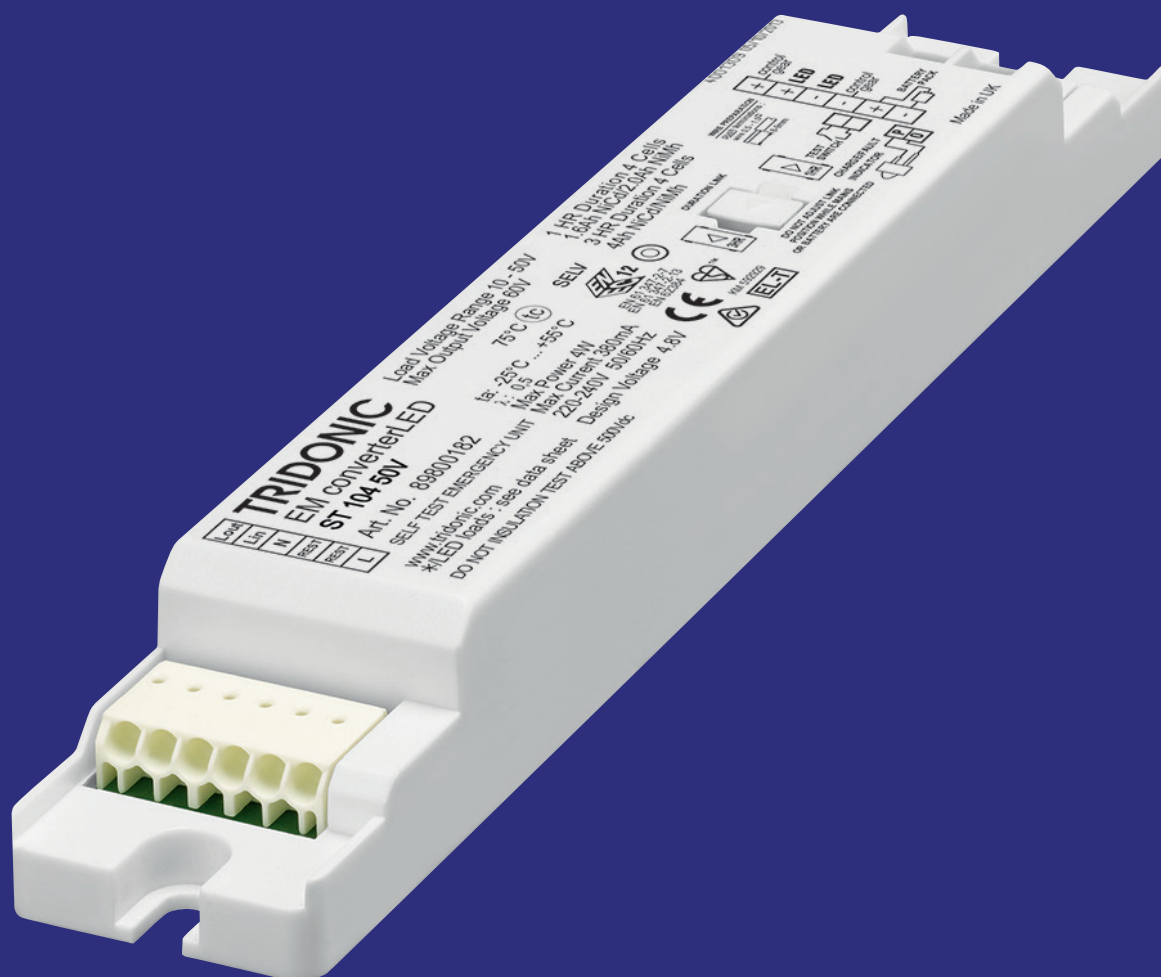

TRIDONIC

Table of Contents

Scope of documentation	4
Validity	4
Copyright	4
Imprint	4
Safety instructions	5
Intended use	5
Dangers associated with the operation of the system	5
Environment	5
Additional instructions	6
Introduction	7
About the device	7
Testing of emergency systems	7
Portfolio of products	8
Housing	8
Forward voltage	8
Functions in emergency operation	9
Adjustable output current	10
Intelligent multilevel charging system	13
Rest mode, Inhibit mode and Relight command	14
Indicator LED	17
Settings for Emergency tests	19
Test times and test intervals	20
Commissioning test	20
Weekly function test	21
Annual duration test	22
Adaptive test mode	22
Functionality of the test switch	22
Determining light output in emergency operation	24
Parameter 1: LED forward voltage	24
Parameter 2: LED current	27
Parameter 3: Light output in emergency operation	34
Compatibility with LED module and LED Driver	35
Compatibility with LED module	35
Compatibility with LED Driver	35
Practical tests	35

Table of Contents

Installation notes 37

Safety information	37
Routing the wires	38

Reference list 40

Related documents	40
Additional information	40

Scope of documentation

1.1. Validity

This operating instruction is valid for LED Drivers for emergency lighting from the EM converterLED ST series.

The series comprises additional versions. However, the other versions EM converterLED PRO and EM converterLED BASIC are not covered within this documentation.

TRIDONIC GmbH & Co KG is constantly striving to improve all its products. This means that there may be changes in shape, features and technology.

Claims can therefore not be made on the basis of information, diagrams or descriptions in these instructions.

The latest version of these operating instructions is available on our home page.

1.2. Copyright

This documentation may not be changed, expanded, copied or passed to third parties without the prior written agreement of TRIDONIC GmbH & Co KG.

We are always open to comments, corrections and requests.

Please send them to info@tridonic.com

1.3. Imprint

Tridonic GmbH & Co KG
Färbergasse 15
6851 Dornbirn
Austria

T +43 5572 395-0

F +43 5572 20176

www.tridonic.com

Safety instructions

The instructions in this section have been compiled to ensure that operators and users of combined emergency lighting LED Drivers of the EM converterLED ST series from Tridonic are able to detect potential risks in good time and take the necessary preventative measures.

The operator must ensure that all users fully understand these instructions and adhere to them. This device may only be installed and configured by suitably qualified personnel.

2.1. Intended use

2.1.1. Proper use

Operation of LED modules in single battery supplied emergency lighting. The device may only be used for this intended purpose.

2.1.2. Improper use

Outdoor use. Extensions and modifications to the product.

WARNING!

Improper use could result in injury, malfunction or damage to property.
It must be ensured that the operator informs every user of existing hazards.

2.2. Dangers associated with the operation of the system

DANGER!

Danger of electrocution
Disconnect the power to the entire lighting system before working on the lighting system!

2.3. Environment

DANGER!

Not to be used in corrosive or explosive environments.

CAUTION!

Risk of damage caused by humidity and condensation

- _ Only use the LED Driver in dry rooms and protect it against humidity!
- _ Prior to commissioning the system, wait until the LED Driver is at room temperature and completely dry!

Safety instructions

2.4. Additional instructions

⚠ CAUTION!

Electromagnetic compatibility (EMC)

Although the device meets the stringent requirements of the appropriate directives and standards on electromagnetic compatibility, it could potentially interfere with other devices under certain circumstances!

Introduction

3.1. About the device



The rapid growth of LED technology within the lighting sector has created a need for suitable emergency lighting systems for luminaires. Thanks to power control in emergency operation, the slim, transparent range of the EM converterLED product group offers utmost flexibility for a number of combinations of LED light sources with LED Drivers by Tridonic and other renowned manufacturers.

As an LED Driver for non-maintained mode, EM converterLED is used in combination with standard and dimmable LED Drivers. It is available as SELV and Non-SELV versions and with different functions. According to SELV classification, versions with a maximum output voltage of 10 - 54 V and 48 - 250 V.

Available are versions for manual testing (BASIC), for selftests (ST) and DALI addressable devices (PRO) for automatically controlled and monitored testing.

This document covers the selftest version (ST) of the portfolio. The PRO version is covered in a separate documentation (see [Reference list](#), p. 40).

3.2. Testing of emergency systems

There are statutory requirements covering the testing of emergency systems in buildings accessible to the public. This includes that testing must be carried out at a time of minimum risk, normally during unsocial hours, and must allow time for the batteries to be recharged before the next expected occupancy of the building.

Without automated test systems all steps must be performed manually. This includes the initiation of the test by interrupting the power supply, the visual inspection of each luminaire and the logging of all test results.

The emergency LED Driver EM converterLED ST enables automated selftesting with a number of advantages:

- _ The EM converterLED ST covers the complete test procedure including error indication. This is possible without any expensive, time-consuming testing procedures. Tests are therefore more reliable and cheaper.
- _ The EM converterLED ST devices are designed to meet the requirements of IEC 62034 (Automatic test systems for battery powered emergency escape lighting).

Portfolio of products

4.1. Housing

The EM converterLED ST is available in a low profile housing (21mm).

Image	Description
	<p>Housing variant compact</p> <ul style="list-style-type: none">- Compact shape- For installations inside the luminaire- Typical area of application: Spotlights, downlights- Dimensions: 179 × 30 × 21 mm

4.2. Forward voltage

The EM converterLED ST is available with two different forward voltages:

10 - 54 V and 48 - 250 V.

Functions in emergency operation

Overview of the main functions in emergency operation:

Area	Function	
Test function, p. 19	Automatic function and duration test	Test activation via selftest
	Function test (interval)	weekly
	Duration test (interval)	annual
Rated duration	Adjustable to 1 or 2 hours	✓
Status display	Via two-colour indicator LED, p. 17	✓
Battery charge system	Intelligent multilevel charging system, p. 13	✓
	Intermittent charging (pulse charging) for NiMH batteries	✓
Adjustment of output current, p. 10	Automatic adjustment by device	✓
Commissioning	Automatic	✓
Rest mode, Inhibit mode and Relight command, p. 14	Activation	Activation via DC pulse

Functions in emergency operation

5.1. Adjustable output current

5.1.1. Description

If the EM converterLED ST switches to emergency operation in case of a power failure, the device will detect the forward voltage of the connected LED modules and set the correct LED current. Setting a constant output power ensures maximum light output in emergency mode for the specified operating time.

An EM converterLED ST with approx. 3, 4 or 5 watts output power operates the connected LED modules with the output power mentioned before. For this purpose, the device detects the connected LED forward voltage, and adjusts the LED forward current to the appropriate value, resulting in an output power of approx. 3, 4 or 5 watts.

NOTICE

At the lowest range of permissible forward voltage, the efficiency may be slightly lower. In this case the output power is also slightly lower.

Functions in emergency operation

5.1.2. Calculation

Formel: $P = U * I$

P	=	U	*	I
Emergency output power: Given by the EM converterLED ST type		LED forward voltage: Detected by the EM converterLED ST		LED forward current: Automatically adjusted by the EM converterLED ST

Example

Given:

- _ LED forward voltage: 45 V (chosen as an example)
- _ LED forward current (at 45 V): 52 mA (taken from diagram EM converterLED ST 203 NiCd/NiMH 50V)

Wanted:

- _ Emergency output power?

Result:

- _ Emergency output power:
 $P = U * I = 45 \text{ V} * 53 \text{ mA} = 2.5 \text{ W}$

Different battery cell numbers offer flexibility in the available emergency output power - 2, 3, 4 and 5 cells for LED modules from 10 V to 250 V forward voltage.

The LED current in emergency mode is automatically adjusted by the EM converterLED ST based on the total forward voltage of the LED modules connected and the associated battery.

Control gear	Forward voltage range	SELV	Number of battery cells
EM converterLED ST 202 NiCd/NiMH 50V	10-54 V	SELV < 60 V	2
EM converterLED ST 203 NiCd/NiMH 50V	10-54 V	SELV < 60 V	3
EM converterLED ST 204 NiCd/NiMH 50V	10-54 V	SELV < 60 V	4
EM converterLED ST 202 MH/LiFePO4 50V	10-54 V	SELV < 60 V	2
EM converterLED ST 203 MH/LiFePO4 50V	10-54 V	SELV < 60 V	3
EM converterLED ST 204 MH/LiFePO4 50V	10-54 V	SELV < 60 V	4

Functions in emergency operation

Control gear	Forward voltage range	SELV	Number of battery cells
EM converterLED ST 203 NiCd/NiMH 250V	48-250 V	no	3
EM converterLED ST 204 NiCd/NiMH 250V	48-250 V	no	4
EM converterLED ST 205 NiCd/NiMH 250V	48-250 V	no	5
EM converterLED ST 203 MH/LiFePO4 250V	50-250 V	no	3
EM converterLED ST 204 MH/LiFePO4 250V	50-250 V	no	4
EM converterLED ST 205 MH/LiFePO4 250V	50-250 V	no	5

NOTICE

There is a separate chapter that describes how the light output in emergency operation can be determined (see [Determining light output in emergency operation](#), p. 24).

Functions in emergency operation

5.2. Intelligent multilevel charging system

The multilevel charging system is used for minimising charging times while maximising battery life. During normal functional mains operation the module charges the batteries using a specially developed charging algorithm.

- _ Initial charge mode:
20 hours (for NiCd/NiMH) or 24 hours (for LiFePO₄) of high charging current at the start to prepare the new battery cells and fully charge them.
- _ Trickle charge mode:
Continuous low charge to maintain battery output and reduce battery temperature.
- _ Fast charge mode:
Automatic adjustment of the charge time ensures minimal overcharging:
 - _ 10 or 15 hours of rapid charge after a full discharge.
 - _ Shorter charge time after only a partial discharge.

When the permanent power supply is switched on for the first time the EM converterLED ST starts to charge the batteries for 20 hours (NiCd/NiMH) or 24 hours (LiFePO₄) in fast charge mode. This 20-hour preparatory charge ensures that the new batteries are completely charged before being used. The 20-hour recharge is also used if a new battery is connected or if the device leaves the Rest mode (see [Rest mode](#), [Inhibit mode](#) and [Relight command](#), p. 14).

At the end of the 20-hour charge the module automatically switches to trickle charge mode. This ensures that the batteries remain at optimum charge levels and avoids any overheating due to overcharging.

- _ NiCd batteries are charged with a constant charging current in trickle charge mode
- _ Special NiMH devices charge with a pulsed charging current in trickle charge mode
- _ LiFePO₄ batteries are charged with voltage-dependent constant current charging

After a power outage and subsequent emergency mode the EM converterLED ST recharges the batteries in fast charge mode. However, the charge time is set so that only the power consumed during emergency mode is replaced. If emergency mode did not last as long as the prescribed operating time the charging time will be reduced. If emergency mode extended for the full operating time the charging time will be 10 hours for modules with an operating time of 1 hour, and 15 hours for modules with an operating time of 2 and 3 hours. Once the batteries are fully charged again the module automatically switches to trickle charge mode.

In trickle charge mode the battery status is continually monitored to ensure that the charging currents and battery voltages remain within the specified limits. The status LED also shows such faults locally.

If a duration test is required while the battery is not yet fully charged the test will be postponed until charging is complete. This prevents a duration test from being carried out with a battery that is not fully charged.

NOTICE

A partially charged battery is defined as one for which the charger is operating in fast charge mode.
A fully charged battery is defined as one for which the charger is operating in trickle charge mode.

If the power supply fails during rapid charging the module will power the lamp immediately in emergency mode for as long as the charge in the batteries will allow.

Functions in emergency operation

5.3. Rest mode, Inhibit mode and Relight command

Emergency operation is automatically started when the mains supply is switched off. If the Rest mode is activated, the discharging of the battery will be minimized by switching off the LED output.

Rest mode can be used during short periods of time when a building is completely unoccupied and the mains supply is to be switched off intentionally, for example during a holiday period. Using Rest mode prevents a full discharge and possible damages to the batteries during these times.

Rest mode has to be activated by a competent person. Activation is only possible after the mains supply has been switched off. Contrary to this, if the Inhibit mode has been activated in advance, Rest mode will be automatically switched on if the mains supply is switched off.

By sending the Relight command both modes, Rest mode and Inhibit mode, will be deactivated. The emergency unit will switch back to the previous operating mode. If it has been in Rest mode, it will switch back to emergency mode, if it has been in Inhibit mode, it will switch back to charging mode.

For all the different changes, activating Rest mode and Inhibit mode and sending the Relight command, DC voltage pulses of different lengths are used. The table at [Switching between operating modes](#), p. 16 gives an overview of all the operating modes.

CAUTION!

Even in Rest mode there is self discharge current and an extremely small level of discharge current flowing from the batteries. If the batteries remain in Rest mode for prolonged periods of time this can lead to deep discharge and potential damage. Further information can be found in the data sheet of the batteries (see [Reference list](#), p. 40).

5.3.1. Activate Rest mode

Rest mode is activated as follows:

- _ Disconnect power supply
- _ Apply DC voltage pulse at the two terminal points "REST/L" and "REST/N"
 - _ The signal must have an amplitude of 9.5 - 22.5 V with a pulse length of 150 - 1,000 ms
 - _ The polarity of the voltage pulse does not matter

NOTICE

Rest mode cannot be activated as long as the power supply hasn't been disconnected.
The maximum number of emergency units on one bus is 100 pieces with a maximum recommended cable length of 1,000 metres.
Rest mode voltage can be applied across all emergency modules (parallel connection).

5.3.2. Deactivate Rest mode via Relight command

By sending the Relight command the Rest mode is deactivated. The emergency unit will switch back to emergency mode.

To deactivate Rest mode via Relight command, proceed as follows:

Functions in emergency operation

- _ Apply DC voltage pulse at the two terminal points "REST/L" and "REST/N"
 - _ The signal must have an amplitude of 9.5 - 22.5 V with a pulse length of 1,001 - 2,000 ms
 - _ The polarity of the voltage pulse does not matter

NOTICE

Reapplying the power supply does also deactivate Rest mode. In this case, the device switches from Rest mode to charge mode.

5.3.3. Activate Inhibit mode

Inhibit mode is activated as follows:

- _ Make sure that the mains supply is switched on
 - _ Apply DC voltage pulse at the two terminal points "REST/L" and "REST/N"
 - _ The signal must have an amplitude of 9.5 - 22.5 V with a pulse length of 150 - 1,000 ms
 - _ The polarity of the voltage pulse does not matter
- > Emergency unit switches to Inhibit mode
-> Inhibit mode is active for a duration of 15 minutes
-> Inhibit mode is indicated by indicator LED (double pulsing GREEN)

For further information see [Indicator LED](#), p. 17.

NOTICE

The inhibit mode must be activated before the mains supply is switched off.

5.3.4. Automatically switch from Inhibit mode to Rest mode

The emergency unit automatically switches from Inhibit mode to Rest mode if the following conditions are met:

- _ Inhibit mode has been activated -and-
- _ Within 15 minutes after activation, the mains supply is switched off

5.3.5. Automatically deactivate Inhibit mode

Inhibit mode is automatically deactivated and the emergency unit switches back to charging mode if the following conditions are met:

- _ Within 15 minutes after activation, the mains supply is **not** switched off

5.3.6. Deactivate Inhibit mode via Relight command

By sending the Relight command the Inhibit mode is deactivated. The emergency unit will switch back to charging mode.

To deactivate Inhibit mode via Relight command, proceed as follows:

Functions in emergency operation

- _ Apply DC voltage pulse at the two terminal points "REST/L" and "REST/N"
 - _ The signal must have an amplitude of 9.5 - 22.5 V with a pulse length of 1,001 - 2,000 ms
 - _ The polarity of the voltage pulse does not matter

5.3.7. Switching between operating modes

The device has four different operating modes (Standby/Charge mode, Emergency mode, Rest mode and Inhibit mode). Depending on the initial mode and the length of the applied DC voltage pulse the device switches between these operating modes. The following table gives an overview:

Applied pulse length	Charging mode	Emergency mode	Rest mode	Inhibit mode
150 - 1,000 ms	Switches to Inhibit mode	Switches to Rest mode	-	-
1,001 - 2,000 ms (Relight command)	-	-	Switches to Emergency mode	Switches to charging mode

Functions in emergency operation

5.4. Indicator LED

System status is locally indicated by a bi-colour indicator LED.

LED indication	Status	Description
Permanent GREEN	Standby, System OK	Mains operation, battery is charged
Fast flashing GREEN (0,1 s on - 0,1 s off)	Function test underway	
Slow flashing GREEN (1 s on - 1 s off)	Duration test underway	
Double pulsing GREEN	Inhibit mode is activated	<p>The Inhibit mode makes it possible to set the emergency mode to "inhibited"; in this mode, the power can be turned off without switching to emergency mode.</p> <p>The Inhibit mode is activated by sending the inhibit signal, while the modules are still connected to mains. Just as in Rest mode, the device supports the Relight functions. After a break of 15 minutes, the inhibit mode is automatically reset.</p>
Permanent RED	Lamp failure	<p>Open circuit -or- Short circuit -or- LED failure</p> <div data-bbox="624 1048 1474 1346" style="border: 1px solid #0070C0; padding: 10px; margin-top: 10px;"> <p>i NOTICE</p> <p>After an exchange of the LED module, the indicator LED remains permanent RED. The lamp failure indication remains set until a function test has been successfully completed (automatically with the weekly function test or immediately by briefly interrupting the power supply or by manually starting the function test with a test switch (see Starting the function test, p. 23)). The LED module's mains operation does not reset the lamp failure indication.</p> </div>
Fast flashing RED (0,1 s on - 0,1 s off)	Charging failure	<p>Incorrect charging current</p> <div data-bbox="624 1491 1474 1789" style="border: 1px solid #0070C0; padding: 10px; margin-top: 10px;"> <p>i NOTICE</p> <p>While the battery is in trickle charge mode and the mains supply is connected, the micro controller in the emergency unit monitors the charging parameters. If an error is detected or a parameter is out of tolerance, the indicator LED switches to fast flashing RED. If the error has been corrected, the indicator LED immediately switches back to GREEN and continues the charging operation of the battery.</p> </div>

Functions in emergency operation

Slow flashing RED (1 s on - 1 s off)	Battery failure	Battery failed duration test or function test -or- Battery is defect -or- Incorrect battery voltage
		<p>i NOTICE</p> <p>Battery failed duration test or function test:</p> <p>If the battery does not reach full operating time, the indicator LED is slow flashing RED.</p> <p>After an exchange of the battery the indicator LED switches to GREEN. To guarantee a satisfactory operating time, the battery is then charged for 20 hours and a second duration test is carried out.</p>
		<p>i NOTICE</p> <p>Battery is defect or incorrect battery voltage:</p> <p>While the battery is in trickle charge mode and the mains supply is connected, the micro controller in the emergency unit monitors the condition of the battery. If an error is detected, the indicator LED switches to RED. If the error has been corrected, the indicator LED immediately switches back to GREEN and continues the charging operation of the battery.</p>
GREEN and RED off	Battery operation	Emergency mode: Mains disconnected -or- mains failure

Settings for emergency tests

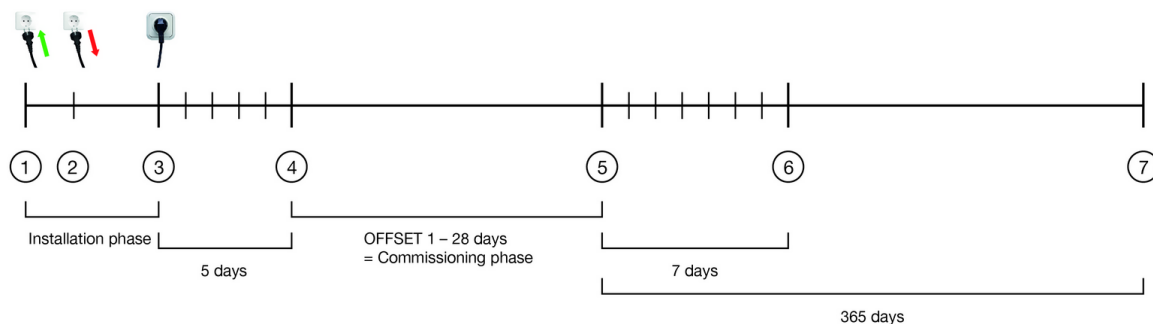

Annotation:

- (1) First connection to the power supply
- (2) Phase, in which the power supply is switched on and off (possibly numerous times)
- (3) Phase, in which the power supply is "permanently" connected (no interruption for at least 5 days)
- (4) Delaying the commissioning test for 1-28 day
- (5) Commissioning test begins
- (6) First function test
- (7) First duration test

Settings for emergency tests

6.1. Test times and test intervals

Devices of the EM converterLED ST series are tested via selftest function. The following table gives an overview of the parameters:

Test trigger	Test times	Test intervals
Test triggered by emergency lighting unit	<p>There are two variants for setting the test time. In some cases different rules apply for the setting of the day and the time:</p> <ul style="list-style-type: none"> _ Automatic setting of the function test: The time of the function test is the same as the time when the device was first connected to the power supply (see (1) in above diagram), the day of the function test is the same as the day when the commissioning test was carried out (see (5) in above diagram and Commissioning test, p. 20). _ Automatic setting of the duration test: The time of the duration test is set by the Adaptive test mode, p. 22, the day of the duration test is the same as the day when the commissioning test was carried out (see (5) in above diagram and Commissioning test, p. 20). _ Manual setting of the test time and the test day for a single luminaire via test switch (see Setting the test time for one luminaire, p. 23). _ Manual setting of the test time and the test day for all the luminaires in an emergency lighting circuit by switching the power supply on and off (see Setting the test time for all the luminaires in an emergency lighting circuit, p. 23). <p>To prevent that the emergency lighting tests of all luminaires are carried out at the same time, each luminaire has a pre-programmed code which delays the test time for a specified time (see Commissioning test, p. 20).</p>	<p>Test time intervals between the tests are fixed:</p> <ul style="list-style-type: none"> _ Function test: weekly _ Duration test: annual

6.2. Commissioning test

The commissioning test is a first duration test. The relevant standard (IEC 62034: Automatic test systems for battery powered emergency escape lighting) requires that such a test is carried out after the installation.

The commissioning test is often made more difficult because the power supply is switched on and off during the installation phase. This is the case, for example, if the site is powered off at night for security reasons. To address this problem, the EM converterLED ST monitors the power supply and will only start with the commissioning test if the power supply hasn't been interrupted for 5 days.

To prevent that all the luminaires perform the emergency test at the same time, each luminaire has a pre-programmed code with a value of 1-28, which delays the test time of that luminaire for a specified time.

- _ Devices with code 1 will be tested one day after the completion of the 5 day long monitoring of the power supply (that is 6 days after the uninterrupted connection to the supply).
- _ Devices with code 2 will be tested two days after the completion of the 5 day long monitoring of the power supply (that is 7 days after the uninterrupted connection to the supply).
- _ Devices with higher code numbers will be tested with a delay that corresponds to that code number.

28 days after the start of the commissioning all devices will have completed the required commissioning test.

The day of the commissioning test serves as a reference point for all further function and duration tests (see [Test times and test](#)

Settings for emergency tests

intervals, p. 20).

Function tests will be performed on the same day in a weekly interval, duration tests will be performed on the same day in an annual interval.

6.3. Weekly function test

The 5 second long, weekly function test serves to check the functionality of the emergency unit, the batteries and the LED module.

The first function test after the commissioning test would normally take place one week after the start of the commissioning test. In the actual implementation of this and all further functional tests two aspects must be considered, however:

- _ To prevent that people are on the site and are disturbed by the test, the start of the function test is delayed until the switched phase is switched off.
 - _ If this is the case, the function test will be carried out 10 seconds later.
 - _ If this is not the case, because the switched phase remains permanently switched on, the function test will be carried out exactly 24 hours later, regardless of whether the switched phase is then turned off or not.

NOTICE

While waiting for the switched phase to be switched off (which can take up to 24 hours), the indicator LED shows that the test has not been carried out satisfactorily (fast blinking GREEN).

- _ If the function test detects a battery failure and the battery was not fully charged at the test time, the device returns to charging mode and starts the function test a second time once the battery is fully charged.

NOTICE

In this case (battery failure and battery not fully charged), the indicator LED does not show an error.

During the charging of the battery, the indicator LED shows that the function test is continuing in the background (fast flashing GREEN).

If the charging of the battery is completed and a function test has been carried out but the status still doesn't change, the indicator LED shows a battery failure (slow flashing RED).

NOTICE

If the power supply is interrupted, the information in the EM converterLED ST is stored for at least one week. If the power supply is interrupted for more than one week, the EM converterLED ST will perform another commissioning test when the power supply returns (after 20 hours initial charge mode).

NOTICE

If the power supply is interrupted during battery replacement, the EM converterLED ST loses its memory contents. When the power supply returns, the EM converterLED ST will charge the battery for 20 hours (NiCd/NiMH) or 24 hours (LiFePO4) and then perform a commissioning test.

Settings for emergency tests

6.4. Annual duration test

The annual duration test checks whether the batteries are able to ensure the required operating time of 1, 2 or 3 hours.

The first duration test after the commissioning test would normally take place exactly one year after the start of the commissioning test.

In the actual implementation of this and all further duration tests two aspects must be considered, however:

- _ To prevent that the duration test is carried out at a time of maximum hazard or highest presence density, the device automatically uses the [adaptive test mode](#), p. 22 to determine a suitable test time.
- _ Furthermore, the test time can be set manually (see [Functionality of the test switch](#), p. 22).

NOTICE

If the power supply is interrupted during battery replacement, the EM converterLED ST loses its memory contents. When the power supply returns, the EM converterLED ST will perform another commissioning test (after 20 hours initial charge mode).

6.5. Adaptive test mode

Adaptive test mode sets the time for the duration test to a time of minimum risk and minimum presence.

This is achieved by monitoring the switched phase of the lighting. This tells the emergency lighting unit which times the lighting is switched off (i.e. no one is in the room) and the unit stores these times. If non-presence of more than five hours is detected the start time for the duration test is set to two hours after the start of the non-presence time.

Example:

A room is not used between 8 pm and 6 am. The lights are switched off. The duration test will therefore begin at 10 pm. This provides a certain buffer before the start and after the end of the duration test, and the batteries can be recharged after the duration test before the room is in use again.

Room usage is monitored on a monthly basis and the time for the duration test is constantly adjusted. This allows for seasonality in room usage to be taken into account.

If a suitable time cannot be found (perhaps because the room is in use round the clock) the duration test is performed at the time set during startup (this is the time when the emergency lighting unit was first connected to the power supply). If subsequently a suitable period is found the time for the duration life test will be suitably adapted.

If none of this is successful because the startup time is unsuitable and no other suitable period can be found, the time for the duration test can be set manually (see [Setting the test time](#), p. 23).

6.6. Functionality of the test switch

The optional test switch enables you to make a series of settings manually.

Settings for emergency tests

i NOTICE

The test switch can remain permanently connected and used as a startup tool.

6.6.1. Starting the function test

- _ A short press on the button (0.15 - 1 s) starts a function test lasting 5 seconds.
 - > The indicator LED flashes GREEN.
 - > The result of the function test is displayed on the two-colour indicator LED.

6.6.2. Starting the test mode

- _ A longer press on the button (1 - 10 s) switches the light source to emergency mode but does not perform a time controlled function test.
 - > On release of the button the emergency units switch back to charge mode.
 - > The indicator LED goes off for 1 second and then on for the rest of the time (maximum of 9 seconds).

6.6.3. Setting the test time

The time and day for the function and duration test is stored in the internal timer. To change the test time, the timer needs to be reset. The previously stored test time will be deleted and replaced by the time of resetting.

i NOTICE

Resetting the timer deactivates the [adaptive test mode](#), p. 22. Because of this, the test time is no longer adapted to the room usage of the building. The function test and duration test is always carried out at the newly set test time.

The timer can be reset for one luminaire or for multiple luminaires:

Setting the test time for one luminaire

- _ Holding down the button (> 10 s) resets the timer.
 - > The indicator LED goes off for 1 second and then shows GREEN and goes off again after 10 seconds.
 - > By going off after 10 seconds the indicator LED confirms that the timer has been successfully reset (to the current time).

Setting the test time for all the luminaires in an emergency lighting circuit

- _ If the unswitched power supply of an emergency lighting circuit is switched on and off 5 times within 60 seconds, the timers for all the emergency units in the emergency lighting circuit is reset (to the current time).

Determining light output in emergency operation

To determine the light output in emergency operation the following parameters are crucial:

1. LED forward voltage (total forward voltage of all connected LED modules)
2. LED current in emergency operation
3. Light output in emergency operation

7.1. Parameter 1: LED forward voltage

- _ The total forward voltage of all connected LED modules must be within the forward voltage range of the EM converterLED ST

7.1.1. Total forward voltage of all LED modules

The forward voltage of a single LED module can be found in the data sheet. When calculating the total forward voltage of all LED modules, series and parallel circuits must be handled differently:

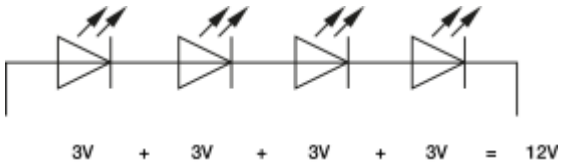
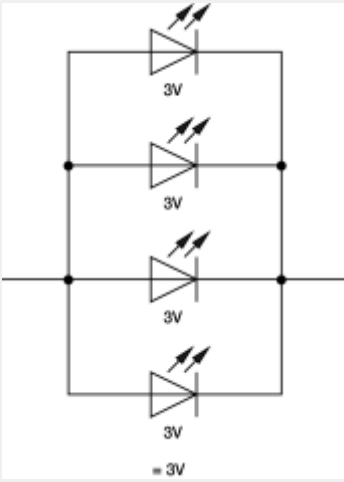
Series circuit	Parallel circuit
 <p style="text-align: center;">3V + 3V + 3V + 3V = 12V</p>	 <p style="text-align: center;">= 3V</p>
<p>The values of the individual LED modules are summed up.</p>	<p>The total value is the same as the value of a single LED module.</p>

Determining light output in emergency operation

7.1.2. Example 1: 1 LED module DLE

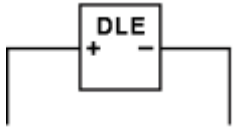

Given:

- _ Forward voltage DLE: 24.2 V (taken from data sheet)

Wanted:

- _ Total forward voltage of all LED modules in emergency operation

Result:

- _ The total forward voltage of all LED modules is 24.2 V because there is only 1 LED module.

Determining light output in emergency operation

7.1.3. Example 2: 2 LED module DLE in parallel

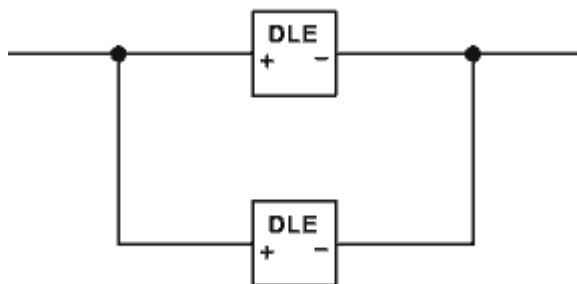

Given:

- _ Forward voltage DLE: 24.2 V (taken from data sheet)

Wanted:

- _ Total forward voltage of all LED modules?

Result:

- _ The total forward voltage of all LED modules is 24.2 V (no addition of the values in a parallel circuit).

i NOTICE

As Example 2 shows, parallel circuits make it possible to use multiple LED modules where the forward voltage does not add up.

Determining light output in emergency operation

7.2. Parameter 2: LED current

Each EM converterLED ST has a specific current/voltage characteristic. The corresponding current/voltage curve can be found in the datasheet:

EM converterLED ST 202 NiCd/NiMH 50V: 10-54V

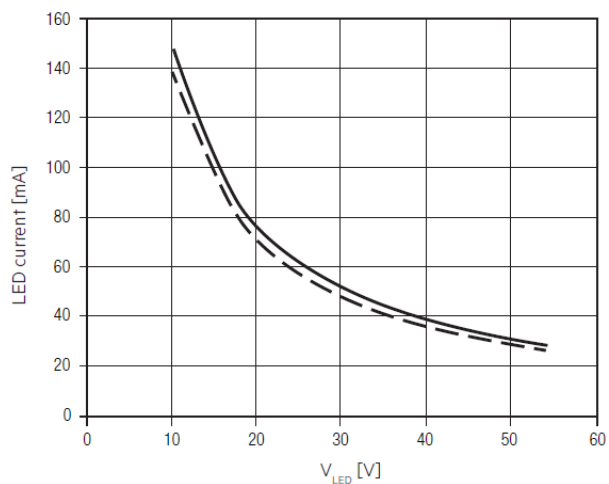

EM converterLED ST 203 NiCd/NiMH 50V: 10-54V

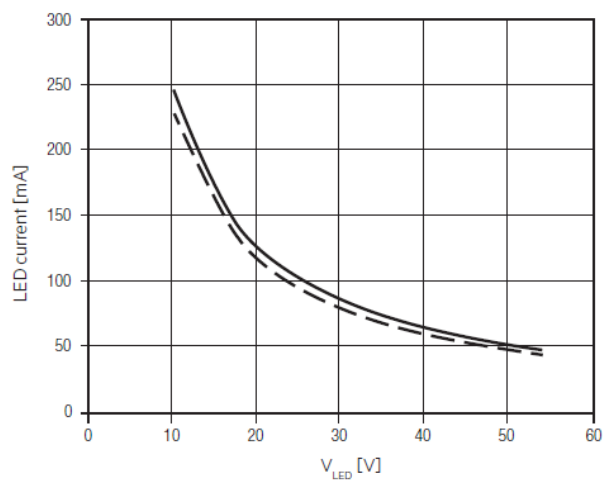

Determining light output in emergency operation

EM converterLED ST 204 NiCd/NiMH 50V: 10-54V

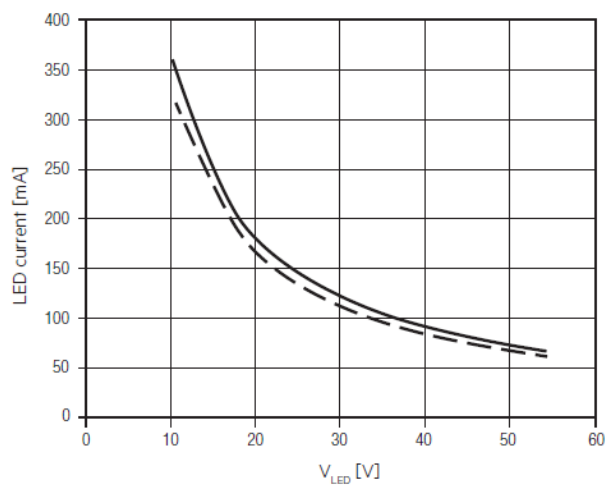

EM converterLED ST 202 MH/LiFePO₄ 50V: 10-54V

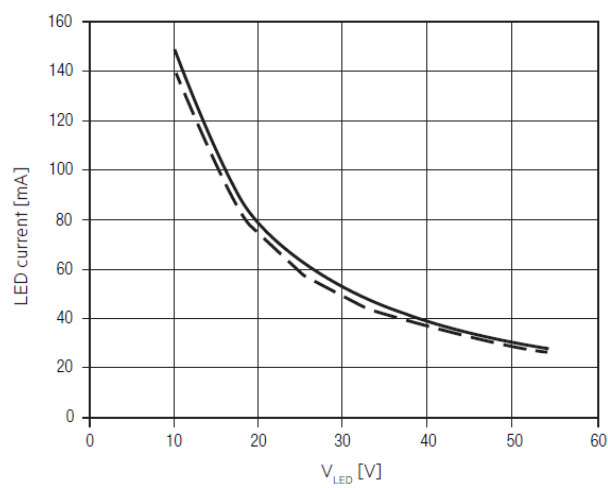

Determining light output in emergency operation

EM converterLED ST 203 MH/LiFePO₄ 50V: 10-54V

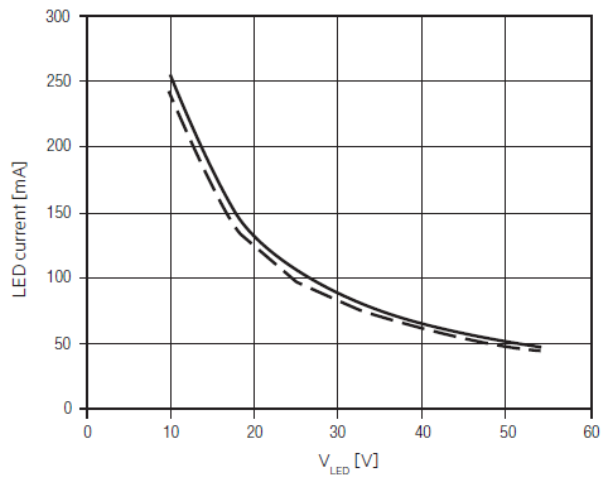

EM converterLED ST 204 MH/LiFePO₄ 50V: 10-54V

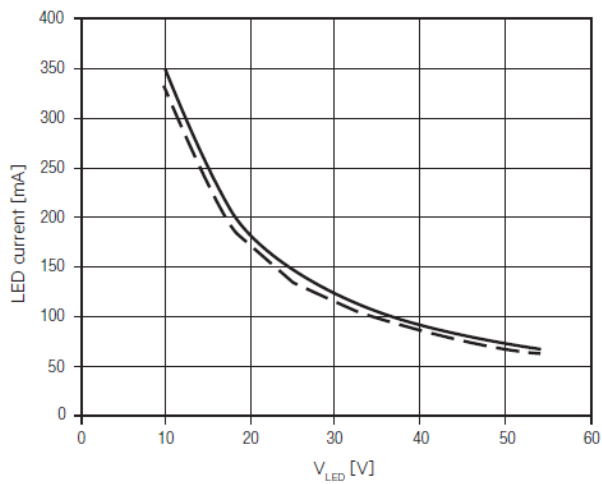

Determining light output in emergency operation

EM converterLED ST 203 NiCd/NiMH 250V: 48-250V

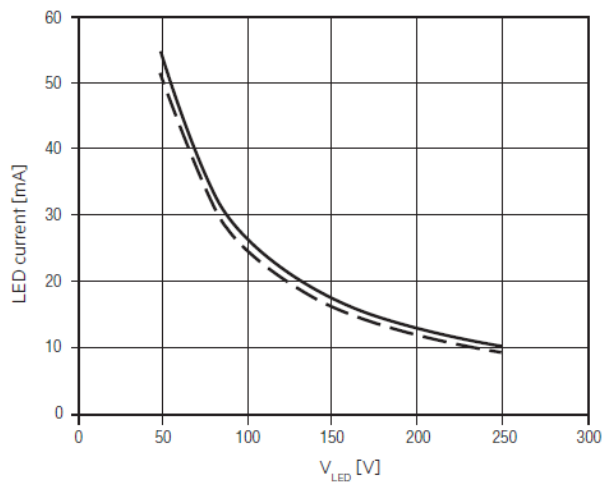

EM converterLED ST 204 NiCd/NiMH 250V: 48-250V

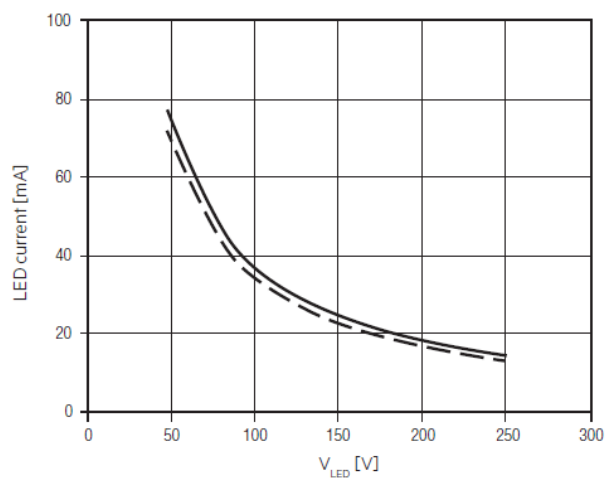

Determining light output in emergency operation

EM converterLED ST 205 NiCd/NiMH 250V: 48-250V

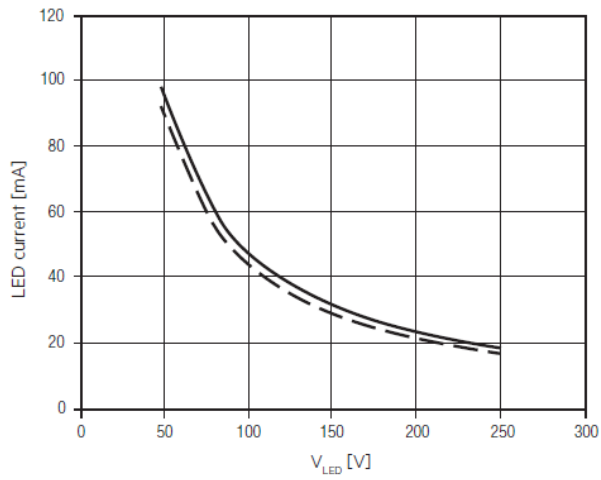

EM converterLED ST 203 MH/LiFePO₄ 250V: 50-250V

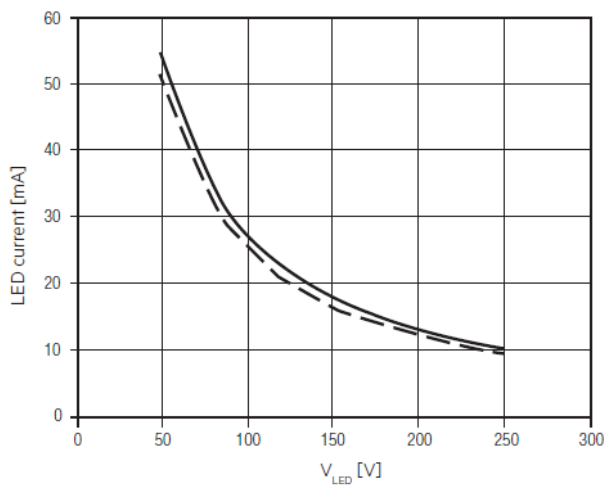

Determining light output in emergency operation

EM converterLED ST 204 MH/LiFePO4 250V: 50-250V

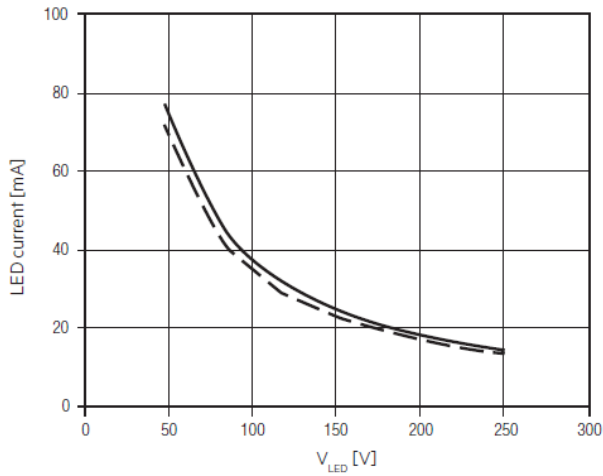

EM converterLED ST 205 MH/LiFePO4 250V: 50-250V

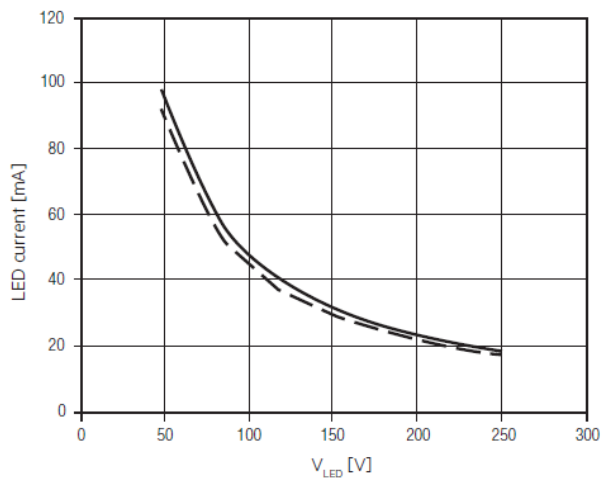

— — — LED current at nominal battery voltage and min. battery discharge current

— — — LED current at nominal battery voltage and max. battery discharge current

Knowing the total forward voltage of all LED modules, the value for the LED current can be read from the current/voltage curve:

- _ Mark the value of the total forward voltage of all LED modules on the x-axis of the graph
- _ From that point move up vertically
- > The crossing points with the two curves define a range of values.

The value of the LED current lies within this range. The effective value depends on tolerances.

Determining light output in emergency operation

7.2.1. Example 1: 1 LED module DLE

Given:

- _ Total forward voltage of all LED modules: 20 V (calculated before)

Wanted:

- _ LED current?

Result:

Figure: Determining LED current for EM converterLED ST 203 NiCd/NiMH 50V

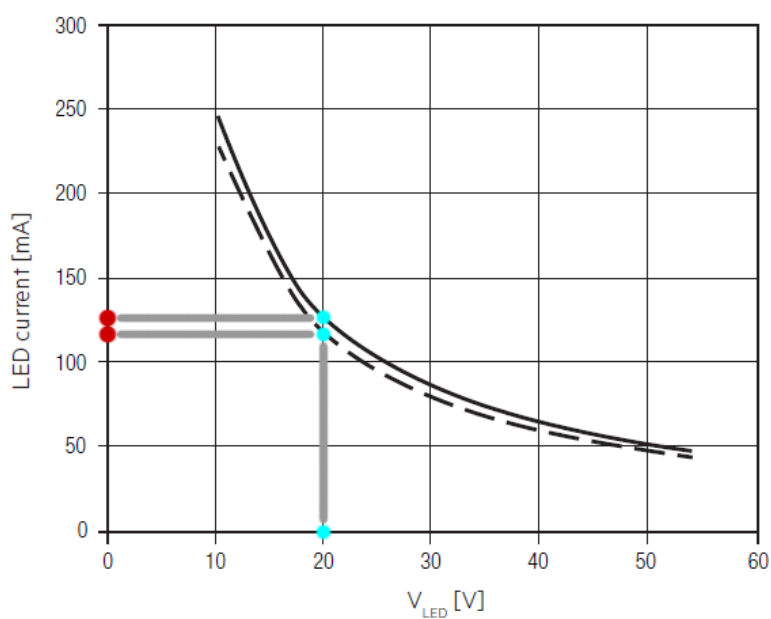

- _ The two crossing points are at around 120 mA (minimum value) and 130 mA (maximum value).
- _ The effective value of the LED current is between these two values.

Determining light output in emergency operation

7.3. Parameter 3: Light output in emergency operation

The ratio between emergency operation and normal operation is the same for light output and LED current. The values for normal operation can be found in the LED module data sheet, the value for the LED current in emergency operation can be found in the data sheet (see example above).

$$\frac{\text{light output in emergency operation}}{\text{light output in mains operation}} = \frac{\text{LED current in emergency operation}}{\text{LED current in mains operation}}$$

With this equation the light output in emergency operation can be isolated and calculated:

$$\text{light output in emergency operation} = \frac{\text{LED current in emergency operation}}{\text{LED current in mains operation}} \times \text{light output in mains operation}$$

7.3.1. Example 1: 1 LED module DLE

Given:

- _ LED current in emergency operation: approx. 65 mA (minimum value) and approx. 75 mA (maximum value) (taken from the previous example, see [Example 1: 1 LED module DLE](#), p. 33)
- _ LED current in mains operation 400 mA (taken from data sheet TW DLE G2 60mm 3000lm 927-965 ArtikelNr.: 89603439)
- _ Light output in mains operation: 2,080 lm (taken from data sheet DLE G3 2000 lm, Article number: 89600574)

Wanted:

- _ Light output in emergency operation?

Result:#

- _ Minimum light output in emergency operation = 65 mA / 400 mA * 2,080 lm = 338 lm
- _ Maximum light output in emergency operation = 75 mA / 400 mA * 2,080 = 390 lm

NOTICE

The Webtool "EM converterLED current calculator" automatically calculates the current and luminous flux and helps with choosing the correct EM converterLED for individual applications. The tool is accessible on: <http://www.tridonic.com/download/emergency/>

Compatibility with LED module and LED Driver

Both, the LED module and the LED Driver used in combination with the EM converterLED ST have to be checked for compatibility.

8.1. Compatibility with LED module

The total forward voltage of all LED modules connected to the EM converterLED ST have to be in its LED module forward voltage range.

- _ EM converterLED ST NiCd/NiMH 50V: 10-54V
- _ EM converterLED ST MH/LiFePO₄ 50V: 10-54V
- _ EM converterLED ST NiCd/NiMH 250V: 48-250V
- _ EM converterLED ST MH/LiFePO₄ 250V: 50-250V

8.2. Compatibility with LED Driver

The EM converterLED emergency unit use 3 pole technology and is compatible with most LED Drivers on the market. However it is important to check that the rating of the LED Driver does not exceed the values specified below:

- _ Max. allowed output current: 2.4 A peak
- _ Max. allowed inrush current rating: 60 A peak for 1 ms, 84 A for 255 μ s
- _ Max. allowed output voltage: 450 V
- _ max. allowed LED load: 150 W

8.3. Practical tests

Practical tests are used to ensure fault-free operation of the LED module and LED Driver. The following aspects must be checked.

8.3.1. Technical aspects

- _ Transient behaviour
- _ Colour shift
- _ Connection during operation
- _ Parasitic capacitance

8.3.2. Visual aspects

- _ Flickering
- _ Stroboscopic effect (video applications)
- _ Dimming behaviour
- _ Colour change/stability
- _ Luminous flux

Compatibility with LED module and LED Driver

8.3.3. Conditions

When conducting the tests the following conditions must be considered:

- _ All tolerances
- _ Entire temperature range
- _ Different output voltage ranges (incl. no load)
- _ Entire dimming range
- _ Short circuit

NOTICE

If the values are slightly over or under the specified threshold values or if there are any other concerns or questions please contact Technical Support: techservice@tridonic.com

Installation notes

NOTICE

The cabling, wiring and mounting for an LED Driver varies depending on the design and manufacturer of the LED module. The following description should therefore not be taken as comprehensive installation instructions but merely as important general information.

To obtain further information, proceed as follows:

- _ Read the documentation provided by the lamp manufacturer. Follow the guidelines and instructions of the lamp manufacturer!
- _ Observe all relevant standards. Follow the instructions given in the standards!

9.1. Safety information

WARNING!

- _ Comply with the general safety instructions (see [Safety instructions](#), p. 5)!
- _ To avoid failures due to ground faults protect the wiring against mechanical loads from sharp-edged metal parts (e.g. cable penetrations, cable holders, metal frames, etc).
- _ Electronic control gear from Tridonic are protected for a maximum of 48 hour against overvoltage of up to 320 V. Make sure that the control gear is not exposed to overvoltage for long periods!
- _ Electronic control gear of the EM converterLED series from Tridonic have type of protection IP 20. Comply with the requirements for this type of protection!

Installation notes

9.2. Routing the wires

9.2.1. Tests

NOTICE

The performance of the prescribed tests and compliance with relevant standards are the responsibility of the luminaire manufacturer.

The following descriptions merely indicate the most important tests and are no substitute for a full research of the relevant standards.

9.2.2. Insulation and dielectric strength testing of luminaires

LED Driver for lamps are sensitive to high-voltage transients. This must be taken into consideration when subjecting luminaires to routine testing during manufacture.

According to IEC 60598-1 Annex Q (for information only!) and ENEC 303-Annex A, each luminaire should be subjected to an insulation test for 1 second at 500 V DC. The test voltage is applied between the linked phase/neutral conductor terminal and the protective earth terminal. The insulation resistance must be at least 2 megaohm.

CAUTION!

As an alternative to measuring the insulation resistance, IEC 60598-1 Annex Q describes a dielectric strength test at 1500 V AC (or $1.414 \times 1,500$ V DC). To avoid damaging electronic control gear, it is strongly disadvised to perform this dielectric strength test.

9.2.3. Type testing

Type testing of the luminaire is performed according to IEC 60598-1 Section 10.

The wiring for protection class 1 luminaires is tested at a voltage of $2xU + 1,000$ V. In order not to overload the control gear all the inputs and outputs of the control gear are connected to one another.

U_{out} is used for measuring the voltage for luminaires with control gear with $U_{out} > 250$ V:

For $U_{out} 480$ V the voltage for the type test is 2000 V.

9.2.4. Wiring

NOTICE

The wiring procedure is device specific. Further information about wiring, wire cross sections and the length of stripped off insulation can be found in the data sheet.

Wiring guidelines

- _ The cables should be run separately from the mains connections and mains cables to ensure good EMC conditions.
- _ Maximum lead length for the test switch and indicator LED connection is 1 m.
- _ The test switch and indicator LED wiring should be separated from the LED leads to prevent noise coupling.
- _ The battery wires are specified with a cross section of 0.5 mm and a max. length of 1 m.

Installation notes

Wiring the plug-in terminal

- _ Use solid wire with the correct cross-section
- _ Strip off correct length of insulation; you may need to twist the tool slightly
- _ Insert the bare end into the terminal

Release of the wiring

- _ Press down the “push button” and remove the cable from front.

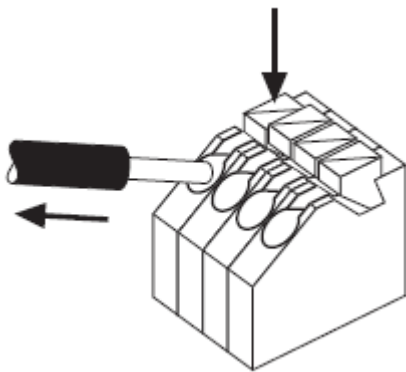

Reference list

10.1. Related documents

- _ Data sheet EM converterLED PRO NiCd/NiMH 50 V
- _ Data sheet EM converterLED PRO MH/LiFePO4 50 V
- _ Data sheet EM converterLED PRO NiCd/NiMH 250 V
- _ Data sheet EM converterLED PRO MH/LiFePO4 250 V
- _ Data sheet EM converterLED ST NiCd/NiMH 50 V
- _ Data sheet EM converterLED ST MH/LiFePO4 50 V
- _ Data sheet EM converterLED ST NiCd/NiMH 250 V
- _ Data sheet EM converterLED ST MH/LiFePO4 250 V

- _ Product description EM converterLED:
https://www.tridonic.com/com/en/download/technical/EM_converterLED_Product-description_en.pdf
- _ Brochure Emergency Lighting: http://www.tridonic.com/com/en/download/Emergency_Lighting_Overview_EN.pdf

10.2. Additional information

- _ EM converterLED current calculator: <https://www.tridonic.com/com/en/products/converterled>
- _ Data sheets: <http://www.tridonic.com/com/en/data-sheets.asp>
- _ Company certificates: <http://www.tridonic.com/com/en/company-certificates.asp>
- _ Guarantee conditions: <http://www.tridonic.com/com/en/guarantee.asp>
- _ Environmental declarations: <http://www.tridonic.com/com/en/environmental-declarations.asp>
- _ LED/lamp matrix: <http://www.tridonic.com/com/en/lamp-matrix.asp>
- _ Operating instructions: <http://www.tridonic.com/com/en/operating-instructions.asp>
- _ Other technical documents: <http://www.tridonic.com/com/en/technical-docs.asp>
- _ Tender text: <http://www.tridonic.com/com/en/tender.asp>
- _ Declarations of conformity: Available documents are found on each product page of our website in the "Certificates" tab for the specific product, www.tridonic.com/com/en/products.asp