

IP20 SELV      

### Driver LCI 35W 900mA-1750mA TOP C

TOP series

#### Product description

- Fixed output built-in LED Driver
- Constant current LED Driver
- Output current settable 900 – 1,750 mA
- Max. output power 35 W
- Nominal life-time up to 100,000 h
- For luminaires of protection class I and protection class II
- Temperature protection as per EN 61347-2-13 C5e
- 5-year guarantee

#### Properties

- Casing: polycarbonate, white
- Type of protection IP20

#### Functions

- Intelligent Temperature Guard (overtemperature protection)
- Intelligent Temperature Management (temperature monitoring of LED module)
- Short-circuit proof
- Overload protection
- Suitable for emergency escape lighting systems acc. to EN 50172

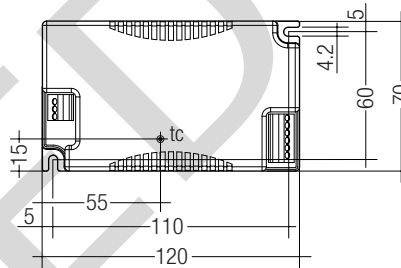
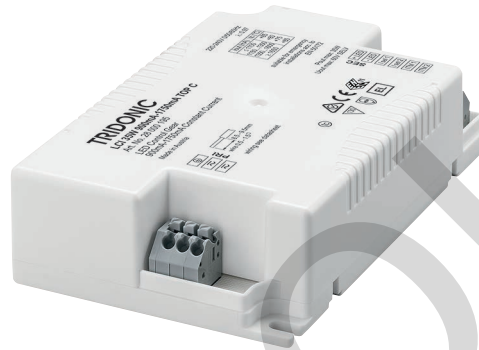

#### Ordering data

Type	Article number	Packaging carton	Packaging pallet	Weight per pc.
LCI 35W 900mA-1750mA TOP C	28000195	10 pc(s).	960 pc(s).	0.158 kg



Standards, page 5

**Technical data**

Rated supply voltage	220 – 240 V
AC voltage range	198 – 264 V
DC voltage range	176 – 280 V (start ≥ 198 V DC)
Mains frequency	0 / 50 / 60 Hz
Overvoltage protection	320 V AC, 48 h
Leakage current (PE)	< 0.5 mA
Max. input power	42.5 W
Efficiency (at 230 V, 50 Hz, full load)	84 – 87 %
THD (at 230 V, 50 Hz, full load)	< 10 %
Output current tolerance	± 5 %
Output LF current ripple (< 120 Hz)	< 2 %
Max. peak output current	Output current + 20 %
Max. output voltage (no-load voltage)	60 V
Time to light	< 0.5 s
Hold on time at power failure or switch-off	< 0.5 s
Switchover time (AC/DC)	< 0.5 s
Burst / surge peaks output side against PE	2 kV
Dimensions L x W x H	120 x 70 x 28.3 mm

**Specific technical data**

Type	Output current	Min. forward voltage	Max. forward voltage	Max. output power	Input power (at 230 V, 50 Hz, full load)	Input current (at 230 V, 50 Hz, full load)	$\lambda$ (at 230 V, 50 Hz, full load)	$t_c$ point	Ambient temperature $t_a$	$t_c/t_a$ for ≥ 50.000 h	I sel resistor value
<b>LCI 35W 900mA-1750mA TOP C</b>	900 mA	17.5 V	38.9 V	35.0 W	40.2 W	181 mA	0.97	85 °C	-25 ... +60 °C	85 / 60 °C	open circuit
	950 mA	16.6 V	36.8 V	35.0 W	40.2 W	181 mA	0.97	85 °C	-25 ... +60 °C	85 / 60 °C	69.80 kΩ
	1,000 mA	15.8 V	35.0 V	35.0 W	40.2 W	180 mA	0.97	85 °C	-25 ... +60 °C	85 / 60 °C	64.90 kΩ
	1,050 mA	15.0 V	33.3 V	35.0 W	40.2 W	180 mA	0.97	85 °C	-25 ... +60 °C	85 / 60 °C	56.00 kΩ
	1,100 mA	14.3 V	31.8 V	35.0 W	40.5 W	181 mA	0.97	85 °C	-25 ... +60 °C	85 / 60 °C	47.50 kΩ
	1,150 mA	13.7 V	30.4 V	35.0 W	40.5 W	181 mA	0.97	80 °C	-25 ... +55 °C	80 / 55 °C	43.20 kΩ
	1,200 mA	13.1 V	29.2 V	35.0 W	40.6 W	182 mA	0.97	80 °C	-25 ... +55 °C	80 / 55 °C	40.20 kΩ
	1,250 mA	12.6 V	28.0 V	35.0 W	40.8 W	183 mA	0.97	80 °C	-25 ... +55 °C	80 / 55 °C	36.50 kΩ
	1,300 mA	12.1 V	26.9 V	35.0 W	40.8 W	183 mA	0.97	80 °C	-25 ... +55 °C	80 / 55 °C	32.40 kΩ
	1,350 mA	11.7 V	25.9 V	35.0 W	41.0 W	183 mA	0.97	75 °C	-25 ... +50 °C	75 / 50 °C	28.70 kΩ
	1,400 mA	11.3 V	25.0 V	35.0 W	41.1 W	184 mA	0.97	75 °C	-25 ... +50 °C	75 / 50 °C	22.00 kΩ
	1,450 mA	10.9 V	24.1 V	35.0 W	41.1 W	184 mA	0.97	75 °C	-25 ... +50 °C	75 / 50 °C	17.80 kΩ
	1,500 mA	10.5 V	23.3 V	35.0 W	41.2 W	184 mA	0.97	75 °C	-25 ... +50 °C	75 / 50 °C	15.00 kΩ
	1,550 mA	10.2 V	22.6 V	35.0 W	41.4 W	185 mA	0.97	75 °C	-25 ... +50 °C	75 / 50 °C	12.10 kΩ
	1,600 mA	9.8 V	21.9 V	35.0 W	41.4 W	185 mA	0.97	75 °C	-25 ... +50 °C	75 / 50 °C	9.30 kΩ
	1,650 mA	9.5 V	21.2 V	35.0 W	41.4 W	185 mA	0.97	80 °C	-25 ... +50 °C	80 / 50 °C	6.49 kΩ
	1,700 mA	9.3 V	20.6 V	35.0 W	41.7 W	187 mA	0.97	80 °C	-25 ... +50 °C	80 / 50 °C	3.83 kΩ
	1,750 mA	9.0 V	20.0 V	35.0 W	41.7 W	187 mA	0.97	80 °C	-25 ... +50 °C	80 / 50 °C	short circuit

**Product description**

- Ready-for-use resistor to set output current value
- Resistor is base isolated
- Resistor power 0.25 W
- Resistor value tolerance  $\pm 1\%$

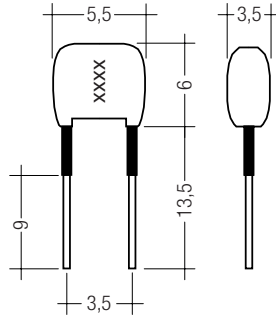

**Ordering data**

Type	Article number	Colour	Marking	Resistor value	Packaging bag	Weight per pc.
I-SELECT PLUG 950mA BR	28000370	Brown	0950	69.80 k $\Omega$	10 pc(s).	0.001 kg
I-SELECT PLUG 1000mA BR	28000459	Brown	1000	64.90 k $\Omega$	10 pc(s).	0.001 kg
I-SELECT PLUG 1050mA BR	28000279	Brown	1050	56.00 k $\Omega$	10 pc(s).	0.001 kg
I-SELECT PLUG 1100mA BR	28000460	Brown	1100	47.50 k $\Omega$	10 pc(s).	0.001 kg
I-SELECT PLUG 1200mA BR	28000461	Brown	1200	40.20 k $\Omega$	10 pc(s).	0.001 kg
I-SELECT PLUG 1300mA BR	28000462	Brown	1300	32.40 k $\Omega$	10 pc(s).	0.001 kg
I-SELECT PLUG 1400mA BR	28000280	Brown	1400	22.00 k $\Omega$	10 pc(s).	0.001 kg
I-SELECT PLUG 1500mA BR	28000464	Brown	1500	15.00 k $\Omega$	10 pc(s).	0.001 kg
I-SELECT PLUG 1600mA BR	28000464	Brown	1600	9.30 k $\Omega$	10 pc(s).	0.001 kg
I-SELECT PLUG 1700mA BR	28000464	Brown	1700	3.83 k $\Omega$	10 pc(s).	0.001 kg
I-SELECT PLUG MAX GR	28000274	Grey	MAX	0 $\Omega$	10 pc(s).	0.001 kg

**Product description**

- Fan driver module with 12.4 V output voltage
- Drives the fan permanently (independent of the optional temperature sensor)
- Terminal IN1 / IN2: stranded wires 0.2 mm<sup>2</sup>, stripped wire endings twisted and tin-plated
- Terminal FAN+ / FAN- and OUT1 / OUT2: 0.2 – 0.75 mm<sup>2</sup> solid or stranded wires twisted and tin-plated, strip wires 6 – 7 mm
- Max. output power of the LED Driver will be reduced by the power consumption of the fan and LCF 12V FAN DRIVER



**Technical data**

Input voltage, DC	25 – 120 V
Output voltage DC	12.4 V
Max. output current (input voltage 25 – 49 V)	50 mA
Max. output current (input voltage 50 – 120 V)	70 mA
Max. power consumption incl. fan (at 30 mA)	0.55 W
Max. power consumption incl. fan (at 50 mA)	0.90 W
Max. power consumption incl. fan (at 70 mA)	1.25 W
tc point	75 °C
Ambient temperature ta (at life-time 50,000 h)	-25 ... +65 °C
Dimensions LxWxH	45 x 23 x 14 mm.

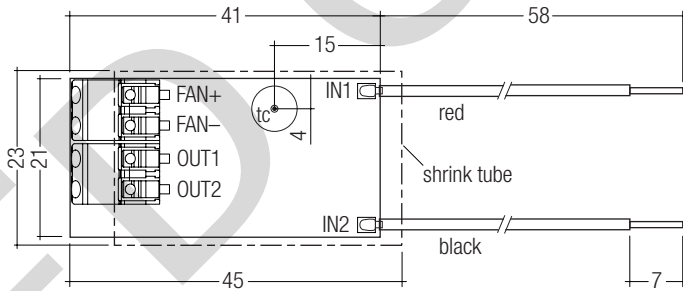

**Ordering data**

Type	Article number	Packaging carton	Packaging pallet	Weight per pc.
LCF 12V FAN DRIVER	28000932	50 pc(s).	1,200 pc(s).	0.01 kg

**Standards**

EN 55015  
EN 61000-3-2  
EN 61000-3-3  
EN 61347-2-13  
EN 62384  
EN 61547  
According to EN 50172 for use in central battery systems  
According to EN 60598-2-22 suitable for emergency lighting installations

Housing fulfils requirements for reinforced insulation according EN 60598-1.

**Output current setting**

Output current can be set by connecting a resistor between the 2 "I sel" terminals. Relationship between output current and resistor value can be found at the table "Specific technical data". Resistor values specified from standardised resistor value ranges.  
Resistor value tolerance has to be  $\leq 1\%$ .  
Resistor power has to be  $\geq 0.1\text{ W}$ .  
If the resistor is connected with wires a max. wire length of 2 m may not be exceeded and possible interferences have to be avoided.  
Resistor detection at each start.  
Change of the resistor value during the operation will be not considered.  
Resistors for the main output current values can be ordered from Tridonic (see accessories).

**DC emergency operation**

The LED Driver is designed for operation on DC voltage and pulsed DC voltage.

Light output level in DC operation (EOF<sub>XL</sub>): 100% (cannot be adjusted)

The voltage-dependent input current of Driver incl. LED module is depending on the used load.

The voltage-dependent no-load current of Driver (without or defect LED module) is for:

AC: < 24 mA  
DC: < 8 mA

**Overload protection**

LED Driver will switch off at overload operation. Mains reset is required to restart the LED Driver.

**Underload operation**

LED Driver will switch off at underload operation. Mains reset is required to restart the LED Driver.

**Overtemperature protection**

The LED Driver will reduce output current at temporary thermal over-heating (exceeding max. tc point). On DC operation this function is deactivated to fulfill emergency requirements.

**Expected life-time**

Type	Output current	ta	40 °C	50 °C	55 °C	60 °C
<b>LCI 35W 900mA-1750mA TOP C</b>	900 – 1100 mA	tc	65 °C	75 °C	80 °C	85 °C
		Life-time	> 100,000 h	> 100,000 h	75,000 h	55,000 h
	1,150 – 1,300 mA	tc	65 °C	75 °C	80 °C	x
		Life-time	> 100,000 h	> 100,000 h	70,000 h	x
	1,350 – 1,400 mA	tc	65 °C	75 °C	x	x
		Life-time	> 100,000 h	90,000 h	x	x
	1,450 mA	tc	70 °C	75 °C	x	x
		Life-time	> 100,000 h	90,000 h	x	x
	1,500 – 1,600 mA	tc	70 °C	75 °C	x	x
		Life-time	> 100,000 h	80,000 h	x	x
	1,650 – 1,750 mA	tc	75 °C	80 °C	x	x
		Life-time	95,000 h	65,000 h	x	x

x = not permitted

The LED Driver is designed for a life-time stated above under reference conditions and with a failure probability of less than 10 %.

**Short-circuit behaviour**

LED Driver will switch off in case of short-circuit of LED output. Mains reset is required to restart the LED Driver.

**No-load operation or load loss during operation**

LED Driver will detect a load loss during operation. In this case and no-load operation the max. output voltage can apply at the LED output for max. 5 s before LED Driver shuts down. Mains reset is required to restart the LED Driver.

**Hot plug-in**

Hot plug-in is not recommend within 5 s after shutdown due to output voltage of > 0 V. Mains reset is required to restart the LED Driver if LED module is connected to the LED Driver after these 5 s.

**Intelligent Temperature Management (ITM)**

ITM offers the possibility to protect the LED module against thermal overload.

Therefore it is necessary to connect the temperature sensor (KTY81/210, KTY82/210) to the corresponding terminals.

If the limit temperature will be exceeded the LED output current will be reduced respectively switched off. After achieving the nominal temperature the LED output current will be increased to the set value again.

Using NTC or PTC resistors is not permitted.

The LED Driver can be used without sensor as well.

**Conditions of use and storage**

Humidity: 5% up to max. 85%, not condensed (max. 56 days/year at 85%)

Storage temperature: -40 °C up to max. +80 °C

The devices have to be within the specified temperature range (ta) before they can be operated.

**Glow-wire test**

according to EN 61347-1 with increased temperature of 850 °C passed.

**Temperature range**

The LED Driver life duration is related to the ambient temperature ta. The relation of tc to ta temperature depends also on the luminaire design. If the measured tc temperature is approx. 5 K below tc max. or higher, ta temperature should be checked and eventually critical components (e.g. ELCAP) measured.

Detailed information on request.

**Maximum loading of automatic circuit breakers**

Automatic circuit breaker type	C10	C13	C16	C20	B10	B13	B16	B20	Inrush current
Installation Ø	1,5 mm <sup>2</sup>	1,5 mm <sup>2</sup>	2,5 mm <sup>2</sup>	2,5 mm <sup>2</sup>	1,5 mm <sup>2</sup>	1,5 mm <sup>2</sup>	2,5 mm <sup>2</sup>	2,5 mm <sup>2</sup>	$I_{max}$ time
<b>LCI 35W 900mA-1750mA TOP C</b>	35	45	55	70	35	45	55	70	9 A 40 µs

**Harmonic distortion in the mains supply (at 230 V / 50 Hz and full load) in %**

	THD	3.	5.	7.	9.	11.
<b>LCI 35W 900mA-1750mA TOP C</b>	10	7	4	3	3	2

**Installation instructions**

**Wiring type and cross section**

The wiring can be in stranded wires with ferrules or solid with a cross section of 0.5–1.5 mm<sup>2</sup> for mains wires and 0.2–1.5 mm<sup>2</sup> for secondary wires.

Strip 9.5 mm of insulation from the cables to ensure perfect operation of the push-wire terminals.

Use one wire for each terminal connector only.

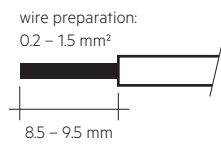

**Release of the wiring**

Press down the “push button” and remove the cable from front.

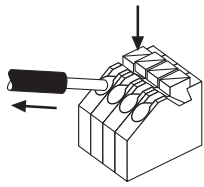

**Mounting of device**

Max. torque for fixing: 0.5 Nm/M4

**Wiring guidelines**

- All connections must be kept as short as possible to ensure good EMI behaviour.
- Earthing is not required for the device to operate but will improve the EMI behaviour.
- If LCI TOP C will be earthed protection earth (PE) has to be used.
- Mains leads should be kept apart from LED Driver and other leads (ideally 5 – 10 cm distance)
- Max. length of output and I sel wires is 2 m.
- Secondary switching is not permitted.
- Incorrect wiring can damage LED modules.
- The wiring must be protected against short circuits to earth (sharp edged metal parts, metal cable clips, louver, etc.).

**Earth connection**

The earth connection is conducted as protection earth (PE). If the LED driver will be earthed, protection earth (PE) has to be used. There is no earth connection required for the functionality of the LED Driver.

Earth connection is recommended to improve following behaviour.

- Electromagnetic interferences (EMI)
- Transmission of mains transients to the LED output

In general it is recommended to earth the LED Driver if the LED module is mounted on earthed luminaire parts respectively heat sinks and thereby representing a high capacity against earth.

**Circuit diagram**

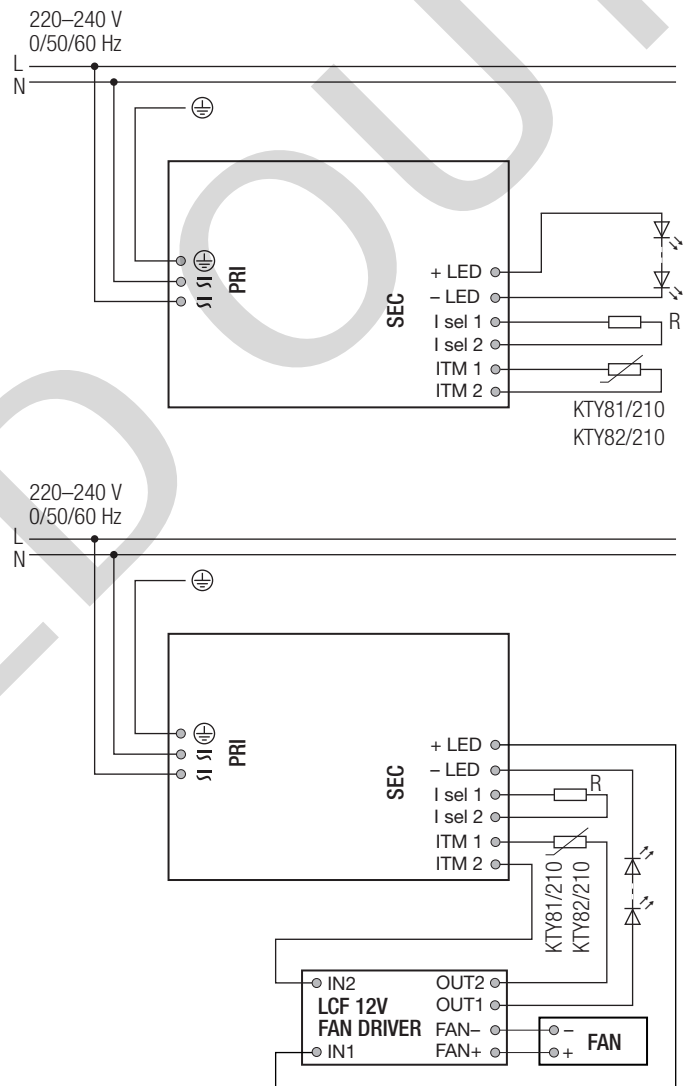

**Isolation and electric strength testing of luminaires**

Electronic devices can be damaged by high voltage. This has to be considered during the routine testing of the luminaires in production.

According to IEC 60598-1 Annex Q (informative only!) or ENEC 303-Annex A, each luminaire should be submitted to an isolation test with 500 V<sub>DC</sub> for 1 second. This test voltage should be connected between the interconnected phase and neutral terminals and the earth terminal. The isolation resistance must be at least 2 MΩ.

As an alternative, IEC 60598-1 Annex Q describes a test of the electrical strength with 1500 V<sub>AC</sub> (or 1.414 x 1500 V<sub>DC</sub>). To avoid damage to the electronic devices this test must not be conducted.

**Diagrams LCI 35W 900mA-1750mA TOP C**

Efficiency vs load

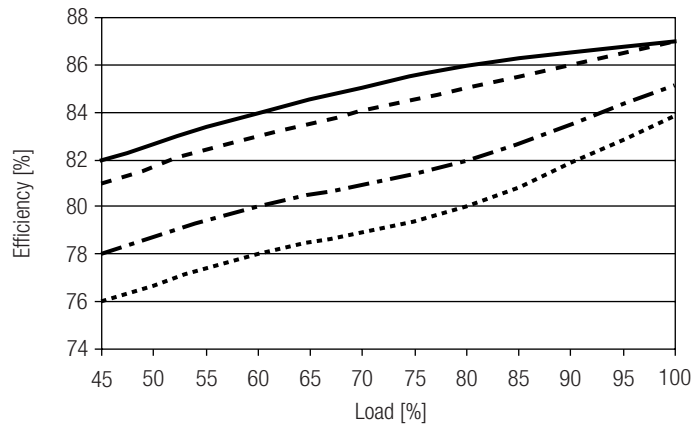

Power factor vs load

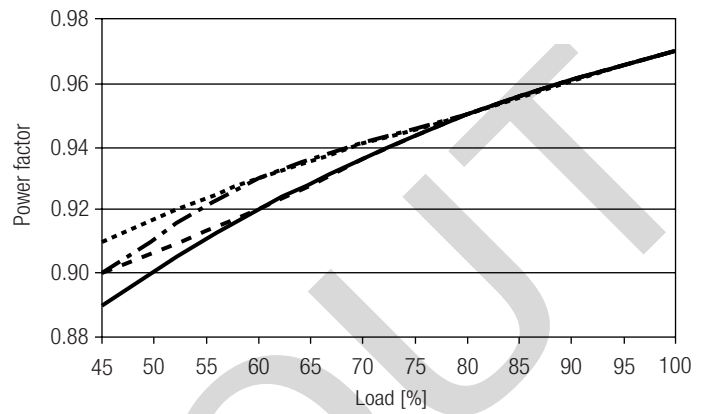

Input power vs load

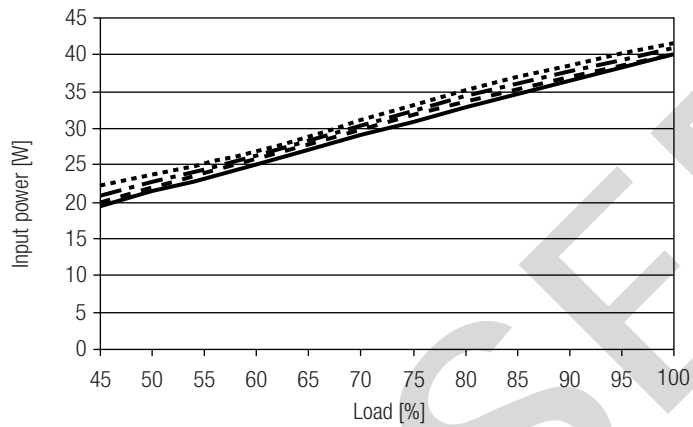

Input current vs load

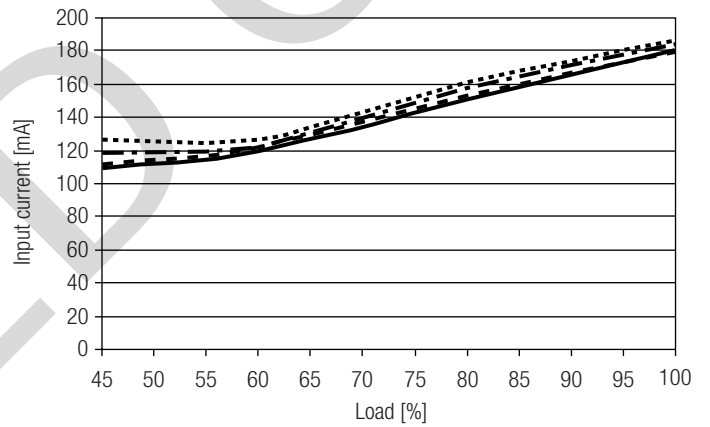

THD vs load

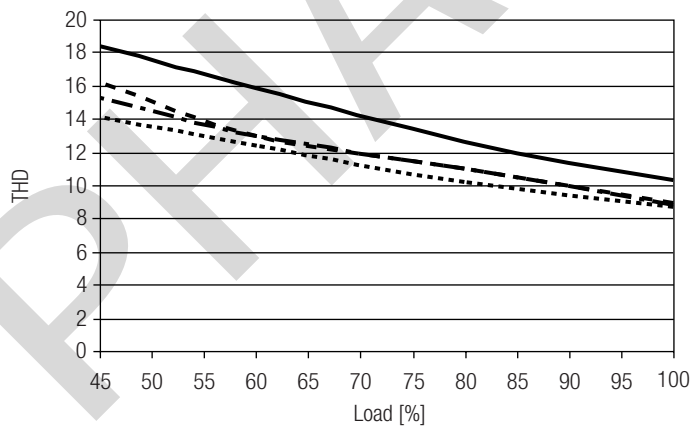

- 900 mA
- - - 1050 mA
- · - · 1400 mA
- · · · 1750 mA

**Additional information**

Additional technical information at [www.tridonic.com](http://www.tridonic.com) → Technical Data

Guarantee conditions at [www.tridonic.com](http://www.tridonic.com) → Services

Life-time declarations are informative and represent no warranty claim.  
No warranty if device was opened.