

### Driver LC 14W 250-350mA flexC R ADV2

advanced round series

#### Product description

- Fixed output built-in LED Driver
- Constant current LED Driver
- For luminaires of protection class I and II
- Adjustable output current 250 or 350 mA
- Up to 90 % efficiency
- For ambient temperatures up to 60 °C
- Nominal life-time up to 50,000 h (at ta 50 °C)
- 5-year guarantee



#### Housing properties

- Casing: polycarbonat, white
- Type of protection IP20

#### Functions

- Overload protection
- Short-circuit protection
- No-load protection

#### Typical applications

- For spot light, track light and wall light in retail and hospitality application



**Standards**, page 3

**Wiring diagrams and installation examples**, page 3

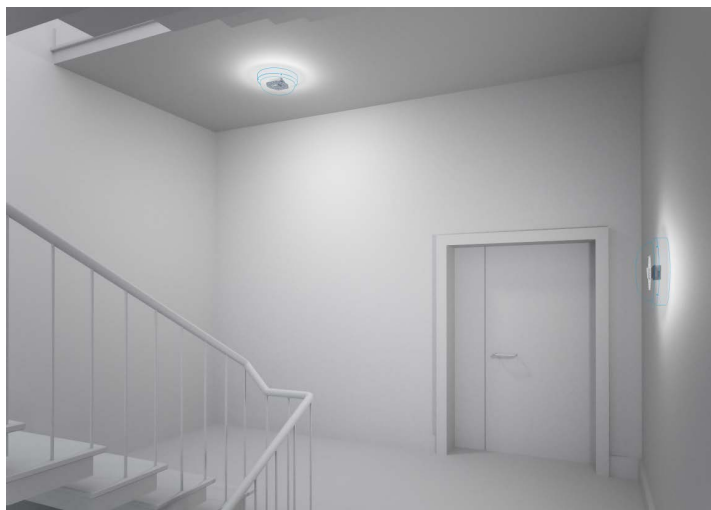

IP20 SELV 

### Driver 14W 250-350mA flexC R ADV2

advanced round series

#### Technical data

Rated supply voltage	220 – 240 V
AC voltage range	198 – 264 V
Mains frequency	50 / 60 Hz
Typ. efficiency (at 230 V / 50 Hz / full load) <sup>①</sup>	90 %
$\lambda$ (at 230 V, 50 Hz, full load) <sup>①</sup>	0.95
THD (at 230 V, 50 Hz, full load) <sup>①</sup>	< 25 %
Output current tolerance <sup>②</sup>	± 7.5 %
Max. output current peak	361 mA
Max. output voltage (U-OUT)	50 V
Typ. output LF current ripple at full load	± 5 %
Output $P_{STLM}$ (at full load)	≤ 1
Output SVM (at full load)	≤ 0.4
Starting time (at 230 V, 50 Hz, full load)	≤ 0.5 s
Turn off time (at 230 V, 50 Hz, full load)	≤ 0.5 s
Hold on time at power failure (output)	0 s
Ambient temperature $t_a$ (at life-time 50,000 h)	50 °C
Storage temperature $t_s$	-20 ... +60 °C
Mains burst capability	1 kV
Mains surge capability (between L – N)	1 kV
Mains surge capability (between L/N – PE)	2 kV
Life-time	up to 50,000 h
Dimensions L x W x H	47 x 42 x 20 mm

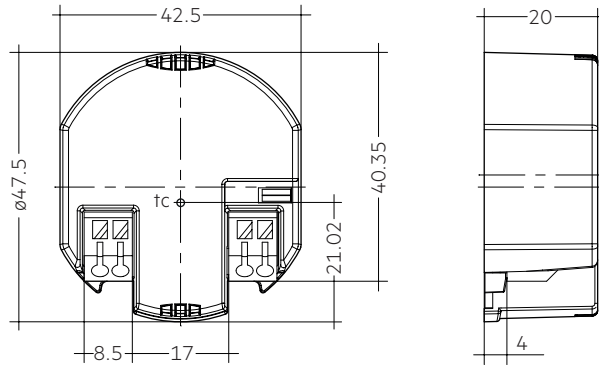

#### Ordering data

Type	Article number	Packaging, carton	Packaging, pallet	Weight per pc.
LC 14/250-350/40 flexC R ADV2	28003210	200 pc(s).	9,600 pc(s).	0.043 kg

#### Specific technical data

Type	Output current <sup>②</sup>	Min. forward voltage	Max. forward voltage	Max. output power	Typ. power consumption (at 230 V, 50 Hz, full load)	Typ. current consumption (at 230 V, 50 Hz, full load)	Max. casing temperature $t_c$	Ambient temperature $t_a$	I-out select
LC 14/250-350/40 flexC R ADV2	250 mA	24 V	40 V	10 W	12 W	60 mA	85 °C	-20 ... +60 °C	open
	350 mA	24 V	40 V	14 W	16 W	80 mA	85 °C	-20 ... +60 °C	short-circuit

<sup>①</sup> Test result at 350 mA.

<sup>②</sup> Output current is mean value.

## 1. Standards

EN 55015  
EN 61000-3-2  
EN 61000-3-3  
EN 61347-1  
EN 61347-2-13  
EN 61547  
EN 62384

### 1.1 Glow-wire test

according to EN 61347-1 with increased temperature of 850 °C passed.

## 2. Thermal details and life-time

### 2.1 Expected life-time

Expected life-time			
Type	ta	50 °C	60 °C
LC 14/250-350/40 flexC R ADV2	tc	75 °C <sup>①</sup>	85 °C <sup>①</sup>
	Life-time	50,000 h	30,000 h

<sup>①</sup> Test result at max. output voltage.

The LED Drivers are designed for a life-time stated above under reference conditions and with a failure probability of less than 10 %.

## 3. Installation / wiring

### 3.1 Circuit diagram

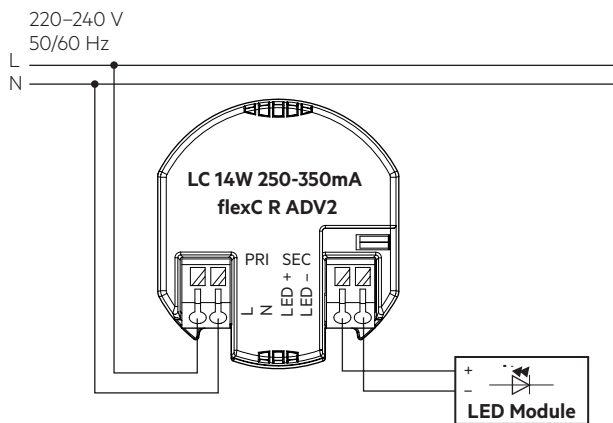

### 3.2 Wiring type and cross section

The wiring can be in stranded wires with ferrules or solid with a cross section of 0.2–1.5 mm<sup>2</sup>. Strip 8.5–9.5 mm of insulation from the cables to ensure perfect operation of the push-wire terminals. Use one wire for each terminal connector only.

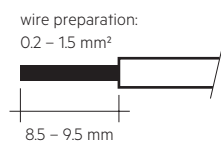

### 3.3 Release of the wiring

Press down the “push button” and remove the cable from front.

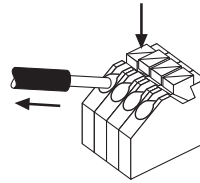

### 3.4 Wiring guidelines

- All connections must be kept as short as possible to ensure good EMI behaviour.
- Mains leads should be kept apart from LED Driver and other leads (ideally 5 – 10 cm distance)
- Max. length of output wires is 2 m.
- The secondary wires (LED module) should be routed in parallel to ensure good EMC performance.
- Secondary switching is not permitted.
- Incorrect wiring can damage LED modules.
- To avoid the damage of the Driver, the wiring must be protected against short circuits to earth (sharp edged metal parts, metal cable clips, louver, etc.).

### 3.5 Replace LED module

1. Mains off
2. Remove LED module
3. Wait for 20 seconds
4. Connect LED module again

Hot plug-in or secondary switching of LEDs is not permitted and may cause a very high current to the LEDs.

## 4. Electrical values

### 4.1 Diagrams

4.1.1 Efficiency vs load

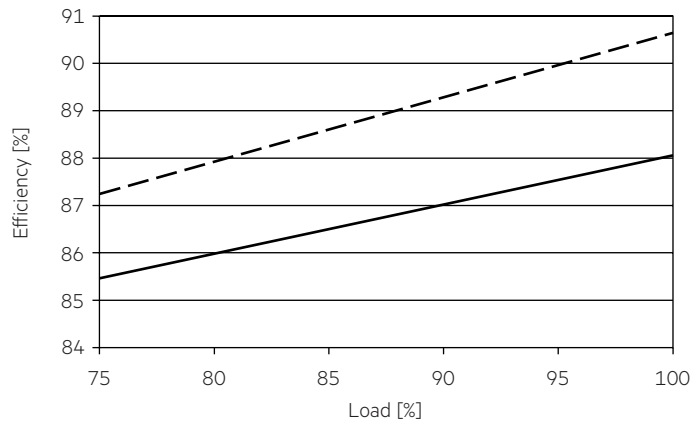

4.1.4 Input current vs load

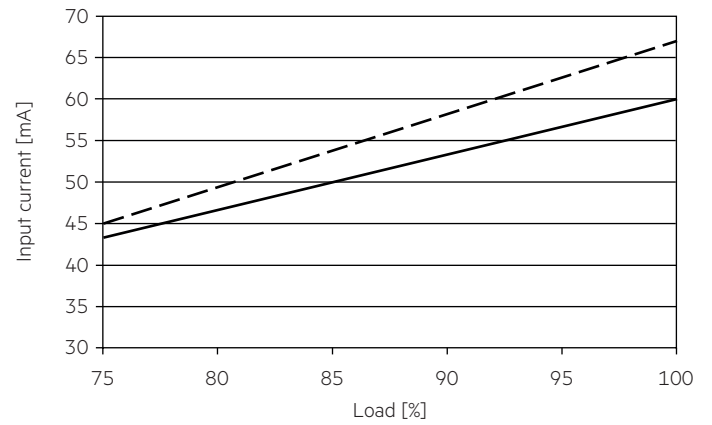

4.1.2 Power factor vs load

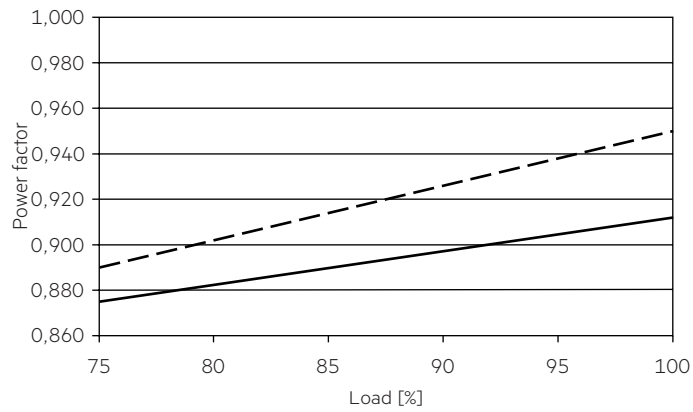

4.1.5 THD vs load

THD without harmonic < 5 mA (0.6 %) of the input current:

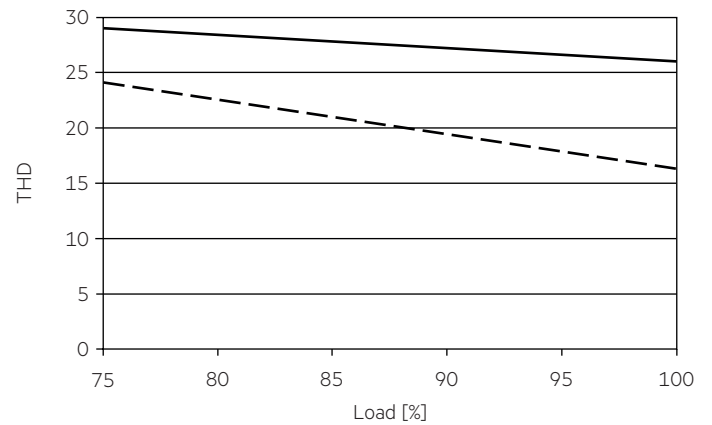

4.1.3 Input power vs load

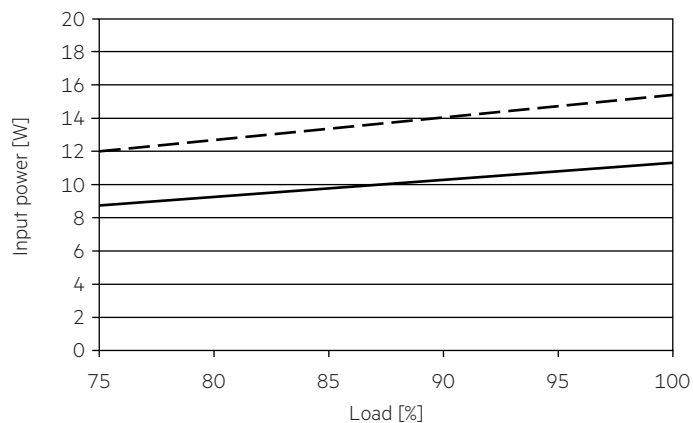

— 250 mA  
- - - 350 mA

#### 4.2 Maximum loading of automatic circuit breakers in relation to inrush current

Automatic circuit breaker type	C10	C13	C16	C20	B10	B13	B16	B20	Inrush current	
Installation Ø	1.5 mm <sup>2</sup>	1.5 mm <sup>2</sup>	1.5 mm <sup>2</sup>	2.5 mm <sup>2</sup>	1.5 mm <sup>2</sup>	1.5 mm <sup>2</sup>	1.5 mm <sup>2</sup>	2.5 mm <sup>2</sup>	I <sub>max</sub>	Time
<b>LC 14/250-350/40 flexC R ADV2</b>	75	91	106	126	45	55	64	76	10 A	152 µs

This are max. values calculated out of inrush current! Please consider not to exceed the maximum rated continuous current of the circuit breaker. Calculation uses typical values from ABB series S200 as a reference. Actual values may differ due to used circuit breaker types and installation environment.

#### 4.3 Harmonic distortion in the mains supply (at 230 V / 50 Hz and full load) in %

	THD	3.	5.	7.	9.	11.
<b>LC 14/250-350/40 flexC R ADV2</b>	< 25	< 18	< 7	< 5	< 4	< 3

Acc. to 6100-3-2. Harmonics < 5 mA or < 0.6 % (whatever is greater) of the input current are not considered for calculation of THD.

## 5. Functions

### 5.1 Short-circuit behaviour

In case of a short circuit on the secondary side (LED) the LED Driver switches off. After elimination of the short-circuit fault the LED Driver will recover automatically.

### 5.2 No-load operation

The LED Driver works in burst working mode to provide a constant output voltage regulation which allows the application to be able to work safely when LED string opens due to a failure.

### 5.3 Overload protection

If the output voltage range is exceeded the LED Driver will protect itself and the output current will decrease till LED flicker. After elimination of the overload, the nominal operation is restored automatically.

## 6. Miscellaneous

### 6.1 Insulation and electric strength testing of luminaires

Electronic devices can be damaged by high voltage. This has to be considered during the routine testing of the luminaires in production.

According to IEC 60598-1 Annex Q (informative only!) or ENEC 303-Annex A, each luminaire should be submitted to an insulation test with 500 V<sub>DC</sub> for 1 second. This test voltage should be connected between the interconnected phase and neutral terminals and the earth terminal. The insulation resistance must be at least 2 MΩ.

As an alternative, IEC 60598-1 Annex Q describes a test of the electrical strength with 1500 V<sub>AC</sub> (or 1.414 x 1500 V<sub>DC</sub>). To avoid damage to the electronic devices this test must not be conducted.

### 6.2 Conditions of use and storage

Humidity: 5 % up to max. 85 %, not condensed (max. 56 days/year at 85 %)

Storage temperature: -20 °C up to max. +60 °C

The devices have to be within the specified temperature range (t<sub>a</sub>) before they can be operated.

### 6.3 Additional information

Additional technical information at [www.tridonic.com](http://www.tridonic.com) → Technical Data

Guarantee conditions at [www.tridonic.com](http://www.tridonic.com) → Services

Life-time declarations are informative and represent no warranty claim. No warranty if device was opened.