

Driver LC 13W 300mA fixC C SNC

essence series

Product description

- Fixed output built-in LED Driver
- Constant current LED Driver
- For luminaires of protection class I and protection class II
- Temperature protection as per EN 61347-2-13 C5e
- Output current 300 mA
- Max. output power 13 W
- Nominal life-time up to 50,000 h
- 5-year guarantee

Housing properties

- Casing: polycarbonat, white
- Type of protection IP20

Functions

- Overload protection
- Short-circuit protection
- No-load protection
- Burst protection voltage 1 kV
- Surge protection voltage 1 kV (L to N)
- Surge protection voltage 2 kV (L/N to earth)



Standards, page 3

Wiring diagrams and installation examples, page 3

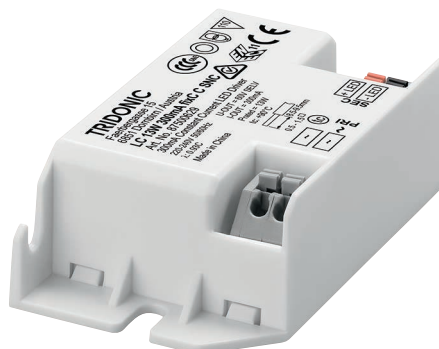

IP20 SELV  RoHS

Driver LC 13W 300mA fixC C SNC

essence series

Technical data

Rated supply voltage	220 – 240 V
AC voltage range	198 – 264 V
Mains frequency	50 / 60 Hz
Overvoltage protection	320 V AC, 1 h
THD (at 230 V, 50 Hz, full load)	< 20 %
Output current tolerance [®]	± 7.5 %
Typ. current ripple (at 230 V, 50 Hz, full load)	± 30 %
Starting time (at 230 V, 50 Hz, full load)	≤ 0.5 s
Turn off time (at 230 V, 50 Hz, full load)	≤ 0.5 s
Hold on time at power failure (output)	0 s
Ambient temperature t_a	-20 ... +50 °C
Ambient temperature t_a (at life-time 50,000 h)	40 °C
Storage temperature t_s	-40 ... +80 °C
Dimensions L x W x H	80 x 40 x 21 mm

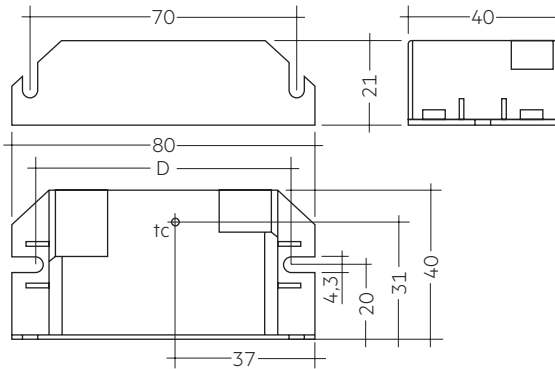

Ordering data

Type	Article number	Packaging, carton	Packaging, low volume	Packaging, high volume	Weight per pc.
LC 13W 300mA fixC C SNC	87500629	25 pc(s).	1,100 pc(s).	7,700 pc(s).	0.043 kg

Specific technical data

Type	Output current [®]	Input current (at 230 V, 50 Hz, full load)	Max. input power	Typ. power consumption (at 230 V, 50 Hz, full load)	Output power range	λ at full load [®]	Efficiency at full load [®]	λ at min. load [®]	Efficiency at min. load [®]	Min. forward voltage	Max. forward voltage	Max. output voltage	Max. output peak current at full load [®]	Max. output peak current at min. load [®]	Max. casing temperature t_c
LC 13W 300mA fixC C SNC	300 mA	72 mA	15.5 W	15.2 W	9.1 – 13 W	0.93C	85 %	0.90C	84 %	30.3 V	43.3 V	60 V	390 mA	390 mA	90 °C

[®] Test result at 230 V, 50 Hz.

[®] The trend between min. and full load is linear.

[®] Output current is mean value.

1. Standards

EN 55015
EN 61000-3-2
EN 61000-3-3
EN 61347-1
EN 61347-2-13
EN 61547
EN 62384

1.1 Glow-wire test

according to EN 61347-1 with increased temperature of 850 °C passed.

2. Thermal details and life-time

2.1 Expected life-time

Expected life-time				
Type	ta	40 °C	50 °C	60 °C
LC 13W 300mA fixC C SNC	tc	80 °C	90 °C	x
	Life-time	50,000 h	30,000 h	x

The LED Drivers are designed for a life-time stated above under reference conditions and with a failure probability of less than 10 %.

3. Installation / wiring

3.1 Circuit diagram

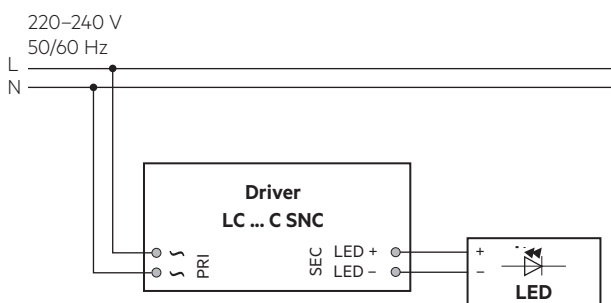

3.2 Wiring type and cross section

The wiring can be done with a cross section of 0.5 – 1.5 mm². Strip 8.5 – 9.5 mm of insulation from the cables to ensure perfect operation of the push-wire terminals.

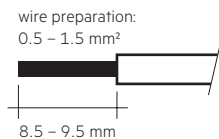

3.3 Release of the wiring

Press down the “push button” and remove the cable from front.

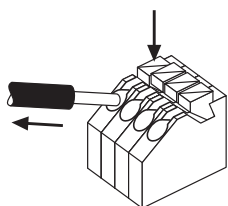

3.4 Wiring guidelines

- All connections must be kept as short as possible to ensure good EMI behaviour.
- Mains leads should be kept apart from LED Driver and other leads (ideally 5 – 10 cm distance)
- Max. length of output wires is 2 m.
- Secondary switching is not permitted.
- Incorrect wiring can damage LED modules.
- To avoid the damage of the Driver, the wiring must be protected against short circuits to earth (sharp edged metal parts, metal cable clips, louver, etc.).

3.5 Replace LED module

1. Mains off
2. Remove LED module
3. Wait for 20 seconds
4. Connect LED module again

Hot plug-in or secondary switching of LEDs is not permitted and may cause a very high current to the LEDs.

3.6 Installation instructions

The LED module and all contact points within the wiring must be sufficiently insulated against 3 kV surge voltage.

Air and creepage distance must be maintained.

3.7 Mounting of device

Max. torque for fixing: 0.5 Nm/M4

4. Electrical values

4.1 Efficiency vs load

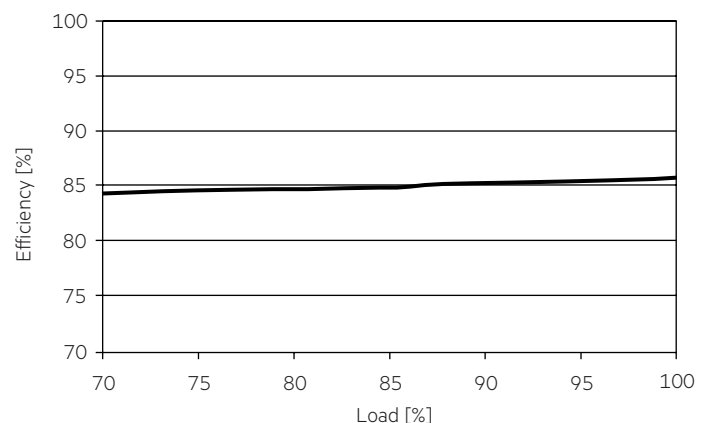

4.2 Power factor vs load

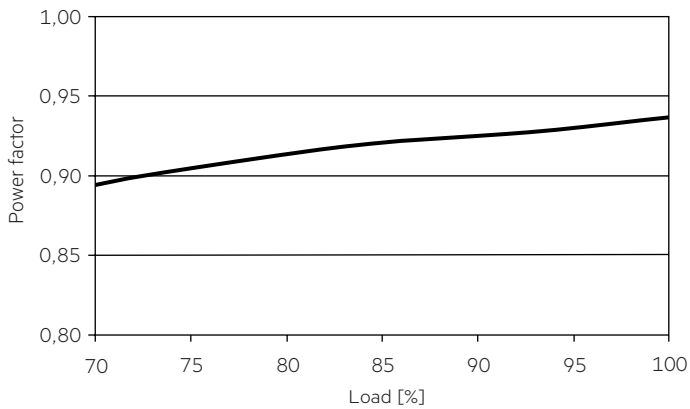

4.4 Input current vs load

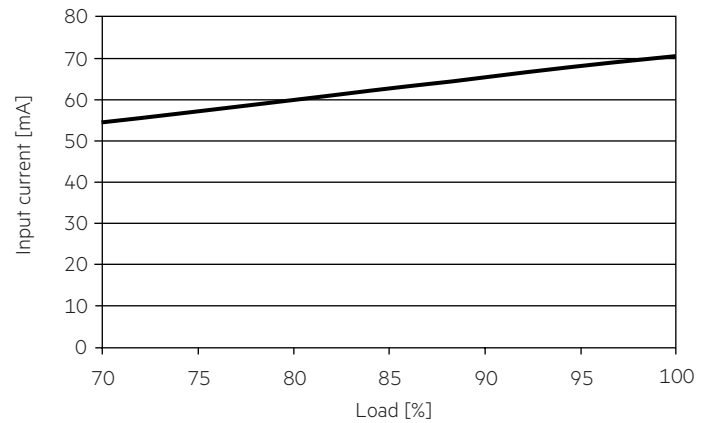

4.3 Input power vs load

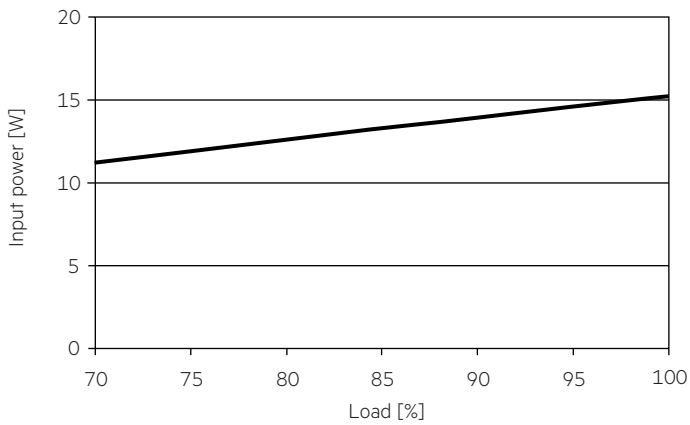

4.5 THD vs load

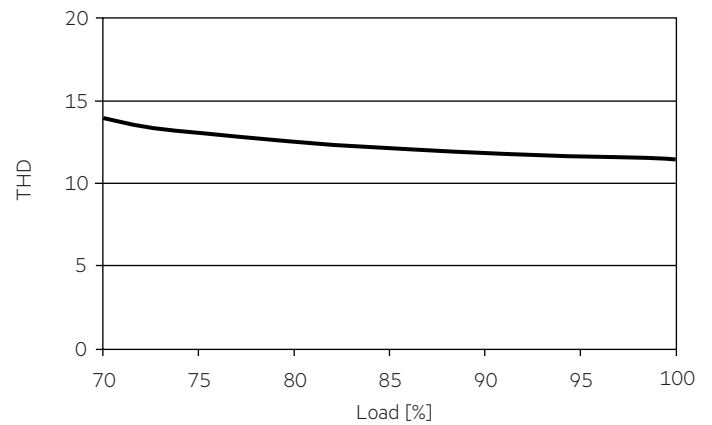

4.6 Maximum loading of automatic circuit breakers in relation to inrush current

Automatic circuit breaker type	C10	C13	C16	C20	B10	B13	B16	B20	Inrush current
Installation Ø	1.5 mm ²	1.5 mm ²	1.5 mm ²	2.5 mm ²	1.5 mm ²	1.5 mm ²	1.5 mm ²	2.5 mm ²	I_{max} Time
LC 13W 300mA fixC C SNC	104	139	173	208	104	139	173	208	3.06 A 35 µs

These are max. values calculated out of continuous current running the device on full load.
There is no limitation due to inrush current.
If load is smaller than full load for calculation only continuous current has to be considered.

4.7 Harmonic distortion in the mains supply (at 230 V / 50 Hz and full load) in %

	THD	3.	5.	7.	9.	11.
LC 13W 300mA fixC C SNC	< 20	< 7	< 7	< 5	< 3	< 3

5. Functions

5.1 Short-circuit behaviour

In case of a short circuit on the secondary side (LED) the LED Driver switches into hic-cup mode. After elimination of the short-circuit fault the LED Driver will recover automatically.

5.2 No-load operation

The LED Driver works in burst working mode to provide a constant output voltage regulation which allows the application to be able to work safely when LED string opens due to a failure.

5.3 Overload protection

If the output voltage range is exceeded the LED Driver will protect itself and LED may flicker. After elimination of the overload, the nominal operation is restored automatically.

6. Miscellaneous

6.1 Insulation and electric strength testing of luminaires

Electronic devices can be damaged by high voltage. This has to be considered during the routine testing of the luminaires in production.

According to IEC 60598-1 Annex Q (informative only!) or ENEC 303-Annex A, each luminaire should be submitted to an insulation test with 500 V_{DC} for 1 second. This test voltage should be connected between the interconnected phase and neutral terminals and the earth terminal. The insulation resistance must be at least 2 MΩ.

As an alternative, IEC 60598-1 Annex Q describes a test of the electrical strength with 1500 V_{AC} (or 1.414 x 1500 V_{DC}). To avoid damage to the electronic devices this test must not be conducted.

6.2 Conditions of use and storage

Humidity: 5 % up to max. 85 %,
not condensed
(max. 56 days/year at 85 %)

Storage temperature: -40 °C up to max. +80 °C

The devices have to be within the specified temperature range (t_a) before they can be operated.

6.3 Maximum number of switching cycles

All LED Driver are tested with 50,000 switching cycles. The actually achieved number of switching cycles is significantly higher.

6.4 Additional information

Additional technical information at www.tridonic.com → Technical Data

Guarantee conditions at www.tridonic.com → Services

Life-time declarations are informative and represent no warranty claim. No warranty if device was opened.